

ADVANCED CONCEPTS OF THE STABILITY OF TWO-WHEELED
VEHICLES--APPLICATION OF MATHEMATICAL ANALYSIS
TO ACTUAL VEHICLES

A thesis submitted to the Graduate School of
the University of Wisconsin in partial fulfillment
of the requirements for the degree of Doctor of
Philosophy.

by
Digvijai Singh

Degree to be awarded

January 19—

June 19⁶⁴

August 19—

To Professors: Easton
Harrison
Feiereisen

This thesis having been approved in respect
to form and mechanical execution is referred to
you for judgment upon its substantial merit.

R. A. Alberty
Dean

Approved as satisfying in substance the
doctoral thesis requirement of the University of
Wisconsin.

Archie H. Easton
Major Professor

A. J. Furusom

H. L. Harrison

Date of Examination, May 27 1964

ADVANCED CONCEPTS OF THE STABILITY OF TWO-WHEELED
VEHICLES — APPLICATION OF MATHEMATICAL ANALYSIS
TO ACTUAL VEHICLES

BY

DIGVIJAI SINGH

A thesis submitted in partial fulfillment
of the requirements for the degree of

DOCTOR OF PHILOSOPHY
(Mechanical Engineering)

at the

UNIVERSITY OF WISCONSIN

1964

AWB
5617
D575

1454293

ACKNOWLEDGMENT

The author expresses his thanks to Mr. Charles Siler of Harley Davidson Motor Co., the sponsor of this research project, for his help in instrumentation and in carrying out the experimental investigations reported in this thesis. A special acknowledgment is due to Mr. Ray Swenson, whose superb driving skill made the road tests as meaningful as they were. The author is grateful to Messrs. William J. Harley and C. L. Spexarth of the Harley Davidson Motor Co., for their technical advice and many valuable suggestions. The Goodyear Tire and Rubber Co. very graciously made available the facilities of their proving ground at San Angelo, Texas, where many of the tests were performed, and thanks are due to Messrs. C. F. Beckett and Earl Dockerty for their help in carrying out those tests. Thanks are also due to Wisconsin State Patrol for the escort provided on the Belt Line for the tests carried out near Madison. The author acknowledges many fruitful and worthwhile discussions with Mr. H. C. Misra with gratitude. The author feels very indebted to Prof. A. H. Easton, his Major Professor, for his able guidance and invaluable help.

TABLE OF CONTENTS

	Page
INTRODUCTION	1
CHAPTER 1	
STABILITY CRITERIA	5
Stability Concept	5
Stability of Motorcycle	11
The Undisturbed Motion	14
Equation of Disturbed Motion	16
Routh Hurwitz Criteria	18
Supplementary Stability Definitions	19
CHAPTER 2	
TIRE FORCES AND MOMENTS	21
Basic Definitions	23
Applicable Tire Characteristics	24
Assumptions	25
CHAPTER 3	
MOTORCYCLE MOTION PHENOMENA	29
CHAPTER 4	
EXTERNAL FORCES AND MOMENTS	41
Basic Variables	41
Sign Conventions and Basic Assumptions	42
Rigid Body Motion	43
Rotating Parts	46
Moment Components	47
Force Components	48
Rotational Components and Slip	48
Translational Components	52
Angular Acceleration Components	54
Translational Acceleration Components	55
Resultant Components of External Forces and Moments	56
CHAPTER 5	
LINEARIZED EQUATIONS OF MOTION	61
Linearized Velocity and Acceleration Components	61

Linearized Angular and Translational Velocities	62
Linearized Angular and Translational Accelerations	62
Additional Approximations	63
Linearized Force Components	63
Linearized Moment Components	64
CHAPTER 6	
SIMULTANEOUS SOLUTION	68
Basic Variables	68
New Variables	68
ELIMINATION OF UNKNOWN \bar{S} OF THE PROBLEM	71
Additional New Variables	72
Further Reduction	73
CHAPTER 7	
NONDIMENSIONAL PARAMETERS	75
Characteristic Length and Mass	75
Nondimensional Lengths	76
Nondimensional Mass	76
Nondimensional Tire Constants	76
Nondimensional Road Speed	77
Nondimensional Moments and Products of Inertia	77
Nondimensional Wind Pressure Constant	77
Nondimensional Steering Damping	78
Nondimensional Driver Input	78
THE FINAL EQUATIONS OF MOTION	78
First Equation	78
Nondimensional Functions	80
Physical Character of Nondimensional Functions	83
Second Equation	84
Nondimensional Functions	87
Physical Character of Nondimensional Functions	91
CHAPTER 8	
SOLUTION OF THE EQUATION OF MOTION AND COMPUTER CODE	92
Computer Program Code	95
Form of the Solutions	97
CHAPTER 9	
RESULTS OF ANALYTICAL SOLUTION	98
Equivalent Initial Conditions	98

Interpretation of Roots	100
Presentation of Data	104
Results of Analytical Solution	106
CHAPTER 10	
EXPERIMENTAL INVESTIGATIONS	127
Development of Instrumentation	127
Final Measuring Device	134
Test Procedure	134
Computation of Damping Coefficients	137
Initial Divergence and Subsequent Damping	140
The Test Variables	141
Results and Conclusions	143
CHAPTER 11	
DISCUSSION OF RESULTS AND CORRELATION	176
CHAPTER 12	
SCOPE OF FURTHER WORK	188
APPENDICES	190
BIBLIOGRAPHY	202

LIST OF FIGURES

Figure	Title	Page
2.1	Sign Conventions	27
2.2	Slip Configuration	28
3.1, 3.2	Gyroscopic Effects	33-37
3.3	Tire Forces and Moments	38
4.1	Vehicle Geometry	53
9.1	σ Study	112
9.2	Rear Tire Study	113
9.3	Front Tire Study	114
9.4	Study of Tire Pairs	115
9.5	Rake Angle Study	116
9.6	Trail Study	117
9.7	I_I^* Study	118
9.8	I_{II}^* Study	119
9.9	m_I^* Study	120
9.10	I_{33I}^* Study	121
9.11	a_I^* Study	122
9.12	h_I^* Study	123
9.13	h_{II}^* Study	124
9.14	a_{II}^* Study	125
9.15	C_f^* — Steering Damping Study	126

10.1	Steering Pickup on Mechanical Extension (Production Model)	128
10.2-a	Relocated Steering Pickup (Trail Setting)	128
10.2-b	Variable Steering Head (Rake Angle Setting)	129
10.2-c	The Experimental Model	129
10.3	Gyroscope on the Rear Fender	130
10.4	Third Wheel Assembly	131
10.5	Lean Angle Pickup on the Third Wheel	131
10.6	Typical Oscillograph Record of θ and ϕ with the Third Wheel	132
10.7	An Actual Test Run (Slave Car)	135
10.8	Schematic of Recording Circuit	136
10.9	Minimized Driver Input	137
10.10	Typical Run on Production Model Illustrating the Method to Read Points	139
10.11	Initial Divergence	140
10.12	Initial Behavior at a Rate Slower than that of Subsequent Damping	141
10.13, 10.14	Oscillograph Records	145-148
10.15-10.35	Experimental Results	150-175
11.1	Driver Input by Shift of His Weight	179

GLOSSARY

I	Subscript designating front system
II	Subscript designating rear system
*	Superscript designating nondimensional values
A_j	Functions of machine parameters, variables θ , ϕ , and their derivatives
\bar{a}	Angular acceleration vector
a_i	Angular acceleration component
B_j	Functions of A_j
a, b, d, h, l, r, R	Motorcycle-geometry terms, Fig. (4.1)
C	Wind resistance coefficients
C_j	Arbitrary constants
C_f	Steering damping parameter
D(det)	Determinant
\bar{F}	External force vector
F_j	External force components
\bar{F}_s	Force acting on element δm
f	Frequency of oscillation
g	Acceleration due to gravity
H_j	Functions of moments and products of inertia
I_{ij}	Moments and products of inertia
I'	Moment of inertia of rotating parts
C_j	Functions of Wind Resistance Parameter

I_j	Functions of moment of inertia of rotating parts and motorcycle geometry
\bar{L}	Angular momentum vector
L_j	Angular momentum components
L'_j	Angular momentum of rotating parts
\bar{M}	External moment vector
M_j	External moment components
M_{jC}	Reaction moment at point of separation
M_{Dr}	Driver input at steering
M_j	Functions of nondimensional mass of the two systems and λ_j
m	Mass of system
\bar{r}	Position vector of center of gravity
\bar{r}_s	Position vector of an elementary mass δm relative to space fixed axes.
T_{jC}	Reaction force component at separation point
T_{jP}	Reaction force component at tire contact patch on pavement
\bar{v}	Velocity vector
v_j	Velocity component
x	Perturbations
x_j	Axes
α	(i) Rake angle (ii) Real part of characteristic root on the Gaussian plane, and stability root on oscillograph record

β	(i) Inclination of front wheel plane from vertical (ii) Frequency parameter in analytical solution
γ	Characteristic equation parameter
γ_j	Characteristic roots
Δ	Determinant
ϵ	Small positive number
ξ_s, η_s, ζ_s	Body fixed axes
ξ_j	Function of motorcycle geometry
θ	Steering angle
Θ	Constant of integration signifying phase angle
κ_j	Linear tire parameters
λ	Slip angle
λ_j	Functions of nondimensional geometrical size of the motorcycle
μ_j	Function of motorcycle constants representing the coefficients of the characteristic equation
ρ	Arbitrary constant on oscillograph records
\bar{p}_s	Position vector with respect to the center of gravity
σ	Tire slip parameter
τ	Time, independent variable
ϕ	Angle of lean
ψ	Angle between the path of the front and the rear wheels
$\bar{\omega}$	Angular velocity vector
ω_j	Angular velocity component
Ω	Angular velocity of rear wheel representing road speed

INTRODUCTION

The present day bicycles and motorcycles are largely the result of empirical design based on experience. Very little theoretical endeavor has been used to develop the single track vehicle.

Back in 1890, F. Klein and A. Sommerfeld were the first to represent mathematically a two-wheeled vehicle (Ref. 13), when they set up the equations of motion for a bicycle. Later, in 1922, Pearsall also published an analytical investigation of the motion of a bicycle (Ref. 16). In those days, not much was known about pneumatic tires. Another study was reported by Döhring and Brunswick in 1955 (Ref. 5), who extended the analysis of Klein and Sommerfeld to set up linearized equations of motion. They measured three commercial vehicles and used their machine constants to solve the equations of motion. A more thorough analytical investigation was carried out by Collins in his Ph.D. dissertation (1963, Ref. 4).

In his study, Collins assumed thin disk wheels without tires and determined the region of automatic stability. He investigated the effect of various motorcycle parameters on the stability coefficients. There is also some additional literature which deals with explaining the motion of two-wheeled vehicles without going into mathematical representation (Refs. 12, 23, 24).

Theoretically, if after applying disturbance forces and displac-

ing a mechanical system from its undisturbed motion, the system returns to its original motion under all possible perturbation of arbitrary magnitude, the motion is said to be totally stable. If the system returns to its original motion under perturbations of sufficiently small magnitude, the system is stable (automatic stability of two-wheeled vehicles). Total stability is a mathematical fiction and does not exist in reality.

In this study, a hypothesis is developed to explain the meaning of stability as applied to the motion of a two-wheeled vehicle. The discussion infers that for stability study, not only the small disturbance forces, but also the inputs of driver, should be disregarded in setting up the equations of motion.

The study is confined to a motorcycle travelling in very nearly upright and straight-ahead trim, on a level road at constant speed. The steering angle and the angle of lean are very small. This permits the linearization of the equations of motion, disregarding the shift of the contact patch of the front tire, and ignoring the effect of suspension.

Small angles allow the use of a pair of linear tires. On the basis of extensive tire data (Ref. 17), suitable constants are assumed to represent a typical tire. Other assumptions have also been made to make the tire effects more realistic.

The driver input term, in the form of a moment about the steering axis, is carried on until the final equation in view of the fact that, if necessary, entirely as a matter of academic interest, an optimal driver control may be investigated for an isolated case of an arbitrary motorcycle situation, specifying some external disturbances to the machine. For the stability study, however, this term is redundant in the equation of motion.

Several road tests were carried out and their results have been included in this study. To give a meaningful interpretation to the roots of the analytical solution, a hypothesis has been established on the basis of the results of the road tests. Comparison and qualitative correlation has been made between the analytical and experimental results.

There is a large number of motorcycle variables. Therefore an indefinitely large number of motorcycle parameters, taking these variables singly or in groups of two or more, can be formed to study their effect on stability. This dissertation essentially presents a theory describing the motion of two-wheeled vehicles and includes the study of only the seemingly more significant parameters. However the nondimensional formulation of the final equation is particularly adaptable to as comprehensive an investigation as desired.

Recommendations have finally been made for the modification

of motorcycle parameters which are likely to improve the motorcycle performance.

The analytical study presented here is applicable to any two-wheeled vehicle. But since a motorcycle was used for the experimental investigations, the two-wheeled vehicle is very often thought of as a motorcycle and is, in the text of this dissertation, frequently referred to as such or even as "machine."

CHAPTER 1

STABILITY CRITERIA

Stability Concept

Every case of a mechanical system corresponding to a mathematically rigorous solution of the differential equations of its motion (or the equations of equilibrium) is not observed in actual practice. To quote one author, "no one has seen a pencil stand vertically on its sharpened end on a smooth horizontal table." This is because small forces and deviations are present not only in the initial state of the mechanical system, but they also act continually. These small disturbances, almost always unknown, have to be ignored even in rigorous theory. But they do exist in reality and affect the motion (or equilibrium), in some cases only slightly and in others strongly.

Toricelli proposed a principle which gave only stable positions of equilibrium. He postulated that "two bodies, which are connected in some manner, cannot move of their own accord unless their center of gravity can fall." The formulation of Torricelli's principle arose from another principle: In a system of solid bodies in a state of equilibrium, the center of gravity occupies the lowest possible relative position.

There is no corresponding dynamic principle for the selection of rigorous solution for stable motion, although stability problems

have occupied the attention of such eminent mathematicians as Lagrange, Kelvin, Routh, Zhukovskii and Poincaré. Lagrange generalized Torricelli's principle, proving the theorem of stability of an isolated equilibrium of a mechanical system when the force function of the forces acting on the system has a maximum. Routh, by simple extension of Lagrange's theorem, developed the method of ignoring cyclical coordinates and found a stability criteria for certain cyclical motions.

The general problem of stability of motion in its classical formulation was solved by Lyapunov (1892). In the definition by Lyapunov, the stability of motion is considered with respect to the disturbances of initial conditions.

Let

$$\frac{dy_j}{d\tau} = Y_j(\tau, y_1, \dots, y_n) \quad j = 1, 2, \dots, n \quad (1.1)$$

represent an arbitrary dynamic system in which y_j are parameters related to motion, as for example, coordinates, velocities, and in general, functions of these quantities.

Consider some particular motion of this system to which corresponds a particular solution $y_j = f_j(\tau)$ of equation (1.1). This motion may be designated as undisturbed motion to distinguish it from all other motions. These other motions are called disturbed motions. The difference between the values of Y_j in some dis-

turbed and the undisturbed motion may be called perturbation.

According to Lyapunov, an undisturbed motion is stable with respect to y_j if for each positive number ϵ , regardless of how small it is, another positive number $\eta(\epsilon)$ can be found such that for all disturbed motions $y_j = y_j(\tau)$, for which at the initial instant $\tau = \tau_0$ the following inequality is true

$$|y_j(\tau_0) - f_j(\tau_0)| \leq \eta, \quad (1.2)$$

and for all values of $\tau > \tau_0$, the following inequality holds

$$|y_j(\tau) - f_j(\tau)| < \epsilon \quad (1.3)$$

An undisturbed motion is called unstable if it is not stable.

The physical significance of Lyapunov's definition is that the stability can be considered with respect to instantaneous disturbances not only of the initial conditions, but also of the equations of motion as well. A direct generalization of Lyapunov's stability, defined for continually acting disturbances, is as follows.

Consider the following system of differential equations along with equations (1.1)

$$\frac{dy_j}{d\tau} = y_j(\tau, y_1, \dots, y_n) + R_j(\tau, y_1, \dots, y_n) \quad (1.4)$$

in which R_j are unknown functions characterizing the disturbing factors regarding which it can only be said that they are sufficiently small and that they satisfy certain general conditions stipulating the solution of eq. (1.4) in the vicinity of undisturbed motion being

considered.

The undisturbed motion $y_j = f_j(\tau)$ (particular solution of equation (1.1)) is stable with constantly acting disturbances, if for each positive number ϵ no matter how small, there exist two positive numbers $\eta_1(\epsilon)$ and $\eta_2(\epsilon)$, such that each solution $y_j(\tau)$ of equation (1.4) satisfying for $\tau = \tau_0$ the inequalities

$$|y_j(\tau_0) - f_j(\tau_0)| < \eta_1(\epsilon) \quad (1.5)$$

satisfies for $\tau > \tau_0$ the inequalities

$$|y_j(\tau) - f_j(\tau)| < \epsilon \quad (1.6)$$

regardless of the nature of function R_j , which satisfy in the region $\tau > \tau_0$ the inequalities

$$|R_j(\tau, y_1, \dots, y_2)| < \eta_2(\epsilon) \quad (1.7)$$

The problem of stability with constantly acting disturbances in most of the practical cases is reduced directly to the problem of stability as defined by Lyapunov for disturbances of initial conditions. In the definition of stability, it is assumed that there are no perturbation forces, i. e., the perturbed motion occurs under the actions of some external forces which are taken into account in determining the unperturbed motion, while the number ϵ is arbitrary and may be as small as required.

The stability problem in the presence of perturbing forces is meaningless, if the latter are in no way constrained. If, from case to case, the perturbing forces vary so little that their variations

have no effect on the linear terms of the equation of disturbed motion, the important practical problem of stability in the first approximation, independent of the terms of higher orders, arises. The stability of motorcycle has been investigated in this same class.

The investigation of stability offers very little difficulty in those cases where the equations of disturbed motion can be integrated in closed form. Lyapunov's predecessors utilized the method of linearization. In the equations of disturbed motion, the aggregate of the terms of power greater than one are disregarded, since in the problem of stability it is natural to expect that the character of the solutions of equations of disturbed motion for very small initial values is determined by the aggregate of the terms of the lowest power. In other words, it is natural to expect that for the solution of the problem of stability, it is sufficient to examine the system of linear equations.

It must be mentioned, however, that the solution of linear approximation may not be rigorous and sometimes may even be incorrect. Substitution of the nonlinear equation by a linear one can be, in some cases, a substitution of one problem by another with which the former may have nothing in common. It may sometime happen that an undisturbed motion upon being investigated only to the first approximation may turn out to be stable, although in reality it

is unstable, and conversely.

Lyapunov divided the methods of solving the problems of stability into two categories. In the first category he included those methods which reduce, in substance, to the direct consideration of disturbed motion. The aggregate of these methods in the first category was termed by Lyapunov "the first method."

For cases in which equation of motion cannot be integrated in closed form, or in which the first method could not be used, Lyapunov developed other methods of solving the problem of stability which do not require finding the solutions of the equations of disturbed motion, but which reduce themselves to finding certain functions of the variables involved having special properties, as for example, Lagrange's method based on maxima of force function. The methods of Lyapunov are much more sophisticated. The aggregate of those methods of the second category was named by Lyapunov "the second method." As the basis of his second method, Lyapunov developed several fundamental theorems. These theorems also enabled him to solve the stability problem by the first approximation and permitted him to examine certain principal cases where the first approximation could not be used. Lyapunov defined several properties, the concept of which gave not only a method of solution but also a very vivid geometrical representation.

For practical purposes it may be necessary not only to determine whether the motion is stable, but also the region of permissible initial disturbance.

Stability of Motorcycle

For the solution of motorcycle stability, the method of linearization has been used. The size of the equations of motion is so formidable that construction of functions called for by the Lyapunov's second method is almost impossible. A considerable effort may solve an isolated case, but since as many as a few hundred motorcycle situations have been solved, it seemed most expedient to linearize the equations of motion. Besides, more important is the fact that the objective of the study is to compare the stability of motorcycle not only at different speeds, but also under different motorcycle situations over a range of road speeds. Such a comparison is not possible by any method other than solving the equations to give the damping coefficients. These coefficients indicate as to how quickly the steering oscillations die out. What is understood by the term "steering oscillation" and other motorcycle motion features is discussed in Chapter 3.

The objection suggested to replace a nonlinear system by a linear system can be effectively answered on the basis of how the stability of a motorcycle is defined and understood. No mathematically

rigorous procedure has been used to justify this substitution since it will not only be an almost impossible task in itself but will completely obscure the objectives of this dissertation.

Road tests have indicated that a steering oscillation of about 2° is the maximum which the machine showed immediately after the steering disturbance was introduced and which looked very significant on the road. In view of the above fact, during normal running, the minute disturbances will produce a steering deflection but only of a fraction of a degree. It is therefore, logical to consider the perturbation, with respect to which the stability is being investigated, as small as desired and call it the linear domain. The region outside this domain, in which the linearized equations may or may not be valid with respect to the motorcycle stability, can be called the nonlinear domain.

If the character of motion is compared, both on the basis of linearized equations of motion and on the basis of rigorous nonlinear equations, there are the following four possibilities.

Cases	Linearized Equations	Nonlinear Equations
1.	Stable	Stable
2.	Unstable	Unstable
3.	Stable	Unstable
4.	Unstable	Stable

In the first two cases, the nonlinear equations would give the same results as those of linear equations. Therefore the study of linear equations is adequate to predict the stability. In the third case, the motorcycle will damp out the disturbance and the motion will be stable as long as the road disturbance is not strong enough to throw the motorcycle oscillation into the nonlinear domain where the oscillations tend to grow. If it happens occasionally, the rider will have to exercise the necessary control and his corrective input will be imperative to bring the machine back into linear domain of stability. A more precise description of the third case is that the motorcycle is conditionally stable. Against the influence of all disturbances, which do not exceed a certain limit, the machine always damps out the oscillations. The driver has to make efforts to control the machine only if a strong disturbance is felt. But in such an event, the driver will react even in Case 1. Hence a machine of Case 3, for all practical purposes, can be called stable. It is also not unlikely that a machine of Case 3 in linear domain may be more stable than a machine of the Case 1 in the same domain. It may be mentioned that this was actually observed in the road tests.

In Case 4, a minute disturbance will produce an oscillation which will grow in the linear domain till the amplitude of the oscillation takes the machine into the nonlinear domain where the

machine is stable, the oscillations will then damp out and the motorcycle will return to the linear domain only to build up the oscillation again. The resulting motion will be an oscillation, like that of an undamped pendulum, with a critical amplitude that lies in the region which distinguishes the two domains. Such a behavior will indeed classify the motorcycle as unstable.

Hence the character of the motion is established in every one of the above four cases on the results of the linearized equations. In the subsequent sections of this chapter, the definitions of undisturbed and disturbed motions lend further support to the above argument.

The Undisturbed Motion

In Chapter 8, the final linearized equation of motion is of the form

$$A_0 \frac{d^4 \theta}{d\tau^4} + A_1 \frac{d^3 \theta}{d\tau^3} + A_2 \frac{d^2 \theta}{d\tau^2} + A_3 \frac{d\theta}{d\tau} + A_4 \theta = 0 \quad (1.8)$$

The characteristic equation of the above ordinary differential equation of the fourth order is

$$A_0 \gamma^4 + A_1 \gamma^3 + A_2 \gamma^2 + A_3 \gamma + A_4 = 0 \quad (1.9)$$

The solution of the polynomial (1.9) gives four nonrepeating roots, two real and two complex, in every motorcycle situation.

$$\gamma = \gamma_1, \gamma_2, \gamma_3, \gamma_4 \quad (1.10)$$

It is now necessary to define the undisturbed motion of a motorcycle. The undisturbed motion of a motorcycle is the one in which

the motorcycle is travelling absolutely upright, and straight ahead at constant speed. If absolutely no disturbances act on the machine, the motorcycle will keep travelling as such for an indefinite period. This is simply the Newton's First Law regarding a body at rest or in uniform motion not acted upon by any force. The undisturbed motion of a motorcycle as defined above requires

$$\theta(\tau_0) = \dot{\theta}(\tau_0) = \ddot{\theta}(\tau_0) = \dddot{\theta}(\tau_0) = 0 \quad (1.11)$$

If the solution of the equation of motion corresponding to the roots of the characteristic equation (1.9) is

$$\theta = C_1 e^{\gamma_1 \tau} + C_2 e^{\gamma_2 \tau} + C_3 e^{\gamma_3 \tau} + C_4 e^{\gamma_4 \tau}, \quad (1.12)$$

the initial conditions (1.11) give

$$\begin{array}{l} C_1 + C_2 + C_3 + C_4 = 0 \\ \gamma_1 C_1 + \gamma_2 C_2 + \gamma_3 C_3 + \gamma_4 C_4 = 0 \\ \gamma_1^2 C_1 + \gamma_2^2 C_2 + \gamma_3^2 C_3 + \gamma_4^2 C_4 = 0 \\ \gamma_1^3 C_1 + \gamma_2^3 C_2 + \gamma_3^3 C_3 + \gamma_4^3 C_4 = 0 \end{array} \quad (1.13)$$

and

$$\det = \begin{vmatrix} 1 & 1 & 1 & 1 \\ \gamma_1 & \gamma_2 & \gamma_3 & \gamma_4 \\ \gamma_1^2 & \gamma_2^2 & \gamma_3^2 & \gamma_4^2 \\ \gamma_1^3 & \gamma_2^3 & \gamma_3^3 & \gamma_4^3 \end{vmatrix} \quad (1.14)$$

The determinant (1.14) can be recognized as Vandermonde determinant, the value of which is not zero for nonrepeating roots.

$$\det \neq 0 \quad (1.15)$$

Therefore by Cramer's rule, the equations (1.13) give

$$C_1 = C_2 = C_3 = C_4 = 0 \quad (1.16)$$

That is, the defined undisturbed motion of the motorcycle is corresponding to the trivial solution of the equation of motion. Or in other words, using the subscript "u" to denote the solution of undisturbed motion,

$$\theta_u = \dot{\theta}_u = \ddot{\theta}_u = \dddot{\theta}_u = 0 \quad (1.17)$$

Equation of Disturbed Motion

The general solution of a differential equation gives an unlimited number of particular solutions corresponding to every arbitrarily specified set of initial conditions. As pointed out earlier, in the definition of stability no perturbation forces were included. All that is required is to specify one motion corresponding to the general solution of the equations of motion and designate it as undisturbed motion to distinguish all other motions which are designated as undisturbed motion. The choice of the undisturbed motion described by equation (1.11), in addition to being the only logical one, is mathematically very expedient.

Using the subscript "u" as before, to denote the solution of undisturbed motion and no subscript to denote any of the other motions, the perturbation and their derivatives are

$$\left. \begin{aligned} x &= \theta - \theta_u \\ \dot{x} &= \dot{\theta} - \dot{\theta}_u \\ \ddot{x} &= \ddot{\theta} - \ddot{\theta}_u \\ \dddot{x} &= \dddot{\theta} - \dddot{\theta}_u \end{aligned} \right\} \quad (1.18)$$

The equation of the disturbed motion in terms of perturbation can be obtained by substituting equations (1.18) into equation

(1.8)

$$\begin{aligned} A_0 \frac{d^4}{d\tau^4} (x + \theta_u) + A_1 \frac{d^3}{d\tau^3} (x + \theta_u) + A_2 \frac{d^2}{d\tau^2} (x + \theta_u) + A_3 \frac{d}{d\tau} (x + \theta_u) \\ + A_4 (x + \theta_u) = 0 \end{aligned} \quad (1.19)$$

From equation (1.8), the equation of the disturbed motion becomes

$$A_0 \frac{dx^4}{d\tau^4} + A_1 \frac{d^3 x}{d\tau^3} + A_2 \frac{d^2 x}{d\tau^2} + A_3 \frac{dx}{d\tau} + A_4 x = 0 \quad (1.20)$$

The equation (1.20) has not changed in form and is same as equation (1.8), except that θ has been replaced by x . In general, x and θ are not equal. However, in the case above, the peculiar choice of undisturbed motion made equations (1.20) and (1.8) identical.

Since the equation (1.20) does not change in the form, in subsequent analysis θ has been used to represent the equation of disturbed motion as well. In fact, θ has been used synonymously to denote both the perturbation and the steering angle.

Routh Hurwitz Criteria

Without having to solve the polynomial (1.9), the Routh Hurwitz method predicts positively the stability of a linear system. The criteria for a n^{th} degree polynomial is as follows.

Let the characteristic equation of degree n be so arranged that $a_0 > 0$

$$D(p) = 0 = a_0 p^n + a_1 p^{n-1} + \dots + a_n$$

The following array is formed to investigate stability

$$D = \begin{vmatrix} a_1 & a_0 & 0 & \cdot & \cdot & \cdot & 0 \\ a_3 & a_2 & a_1 & \cdot & \cdot & \cdot & 0 \\ a_5 & a_4 & a_3 & \cdot & \cdot & \cdot & 0 \\ \vdots & \vdots & \vdots & \vdots & \vdots & \vdots & \vdots \\ a_{2n-1} & a_{2n-2} & \cdot & \cdot & \cdot & \cdot & a_n \end{vmatrix} \quad (1.21)$$

in which all letters with subscript greater than n are replaced by zero.

In order that the system be stable, all successively larger determinants on the main diagonal (the principal minors)

$$\Delta_1 = a_1, \quad \Delta_2 = \begin{vmatrix} a_1 & a_0 \\ a_3 & a_2 \end{vmatrix}, \text{ etc. should satisfy the inequality}$$

$$\Delta_i > 0 \quad (i = 1, 2, \dots, n) \quad (1.22)$$

This is because all the roots of the characteristic equation will have negative real parts if and only if all $\Delta_i > 0$. Thus, any determinant coming out negative means that there is at least one positive root and the entire system is unstable.

This criteria can readily be used as a convenient tool to check the stability of an isolated case. But for comparison purposes the knowledge of the roots themselves is essential and the polynomial (1.9) has to be solved.

Supplementary Stability Definitions

In a recent S. A. E. seminar (S. A. E. Journal, Feb. 1964), two terms, "Neutral Stability" and "Asymptotic Stability," were defined and recommended for the use of S. A. E. Recommendation Practice. These terms only express the concepts which Lyapunov gave, when he defined some basic terms and formulated his theorems in the development of his second method.

The S. A. E. definitions are as follows:

Neutral Stability exists at a prescribed trim if a temporary change in control or disturbance input can be found such that the resulting motion of the vehicle remains arbitrarily close to, but does not approach, the motion defined by the trim.

Asymptotic Stability exists at a prescribed trim if, for any small, temporary change in control or disturbance input, the vehicle will approach the motion defined by the trim.

Lyapunov defined two concepts for a function "V" of the variables involved in the equations of motion, and called them "sign definite" and "sign constant." His theorems are as follows.

Theorem A: If for the differential equations of a perturbed motion, it is possible to find a sign definite function V, the total derivative of which with respect to time $\frac{dV}{dt}$ (by reason of the equations of motion) is a sign constant function opposite in sense to V, or which identically reduces to zero, the unperturbed motion is stable.

Theorem B: If for the differential equations of a perturbed motion, it is possible to find a sign definite function V, the total derivative of which with respect to time $\frac{dV}{dt}$ (by reason of the equations of motion) is sign definite function opposite in sense to V, the unperturbed motion is asymptotically stable.

The stability situation resulting from Theorem A is what the SAE definition of Neutral Stability signifies, and the Asymptotic Stability of the S. A. E. is the consequence of Lyapunov's Theorem B.

In a motorcycle, the asymptotic stability is desirable. Neutral stability can be accepted if the actual motion stays very close to the undisturbed motion defined earlier in this chapter.

CHAPTER 2

TIRE FORCES AND MOMENTS

In a four-wheeled vehicle, aside from aerodynamic inputs, all other forces influencing the motion of the vehicle are applied through the tire road contact. But in a single track vehicle, such as a motorcycle, even a straight ahead motion is affected by the centrifugal force, the vehicle must generate (by going momentarily into a curve) to resist a fall that may have initiated. Momentarily going into and out of curvature is strongly related to the forces and moments generated at the contact patch of the front wheel.

The primary forces and moments which affect the directional control properties of wheeled vehicles are those between the road and the rolling tire. These moments and forces are nonlinear functions of a large number of parameters such as slip angle, camber angle, vertical load, tire road friction coefficient, and traction force, among others. The interaction between the tire and the road is a distributed force system over the contact patch, which is made up of normal pressure and shear stress distribution. How the stress distribution varies under the influence of circumferential forces has not yet been investigated. H. Martin (Ref. 6) supports the approximation of the true pressure stress distribution over the length of contact surface by a quadratic and the true shear stress distribution

by a cubic parabola. So far, no analytical study has resulted in a sufficiently accurate mathematical model to satisfactorily represent the complex interactions and nonlinearities of real tires.

Lately, some elaborate tire testing machines have been developed on which extensive tire testings have been done (Refs. 8, 17, and 18). But tire data for the tires used for Harley Davidson Machines are not available. Since for the stability study, machine constants themselves are not taken for Harley Davidson motorcycles, the actual tire data for the tires used on those machines are of little consequence. The machine constants are taken from Ref. 4, which are representative of any motorcycle.

A variety of tires were tested on G. M. Tire Testing Machine (Ref. 17). Though one type of tire was different from another, the general tire characteristic is very much the same for all tires, especially at small slip and camber angles. This fact suggested a possibility to use the G. M. tire data in establishing a system of linear tire constants, valid for small values of θ and ϕ , to investigate the stability of motorcycle. To fully comprehend the assumptions made regarding these tire constants, a brief outline of the general tire characteristics is in order. This outline is given later in this chapter.

In including the tire effect to study the motorcycle behavior, all the terms denoting tire forces and moments, and related geometrical

configurations have been used according to the revised definitions or Nordeen and Cortese (June 1963, Ref. 17). These definitions have been approved in a recent S. A. E. seminar at Detroit as the basis for an S. A. E. Recommendation Practice. The S. A. E. approved definitions require the use of "inclination angle" instead of "camber angle" as suggested by Nordeen and Cortese.

Basic Definitions

The tire terms involved in the stability study have the following definitions.

Wheel Plane is the central plane of tire, normal to the axis of rotation.

Wheel Center is the point at which the axis of rotation intersects the wheel plane.

Center of Tire Contact is the intersection of the wheel plane and a vertical plane through the axis of rotation of the wheel projected onto the road plane.

Origin of the Tire Axis System is the center of tire contact. The x_1 -axis is the intersection of the wheel plane and the road plane with the positive direction forward. The x_3 -axis is perpendicular to the road plane with the positive direction downward. The x_2 -axis is in the road plane with an orientation to make the axes system orthogonal and right handed.

Tractive Force is the component of the force acting on the tire by the road in the x_1 -direction.

Lateral Force is the component of the force acting on the tire by the road in the x_2 -direction.

Normal Force is the component of the force acting on the tire by the road in the x_3 -direction.

Overturning Moment is the moment of the forces acting on the tire by the road with respect to x_1 -axis.

Aligning Torque is the moment of the tire contact forces acting on the tire by the road with respect to x_3 -axis.

Slip Angle is the angle formed between the direction of travel on the center of contact and x_1 -axis.

Camber Angle is the angle formed between the x_1 - x_3 plane and the wheel plane.

Cornering Force is the lateral force when the camber angle is zero.

Camber Force is the lateral force when the slip angle is zero.

Cornering Stiffness is the derivative of cornering force (lateral force — S.A.E. definition) with respect to slip angle evaluated at zero slip (S.A.E. definition does not specify 'at zero slip').

Camber Stiffness is the derivative of the camber force (lateral force — S.A.E. definition) with respect to camber angle evaluated at zero camber angle (S.A.E. definition does not specify 'at zero camber angle').

Applicable Tire Characteristics

One of the most significant characteristics of the tires is that tire forces and moments are quite independent of the road speed (Ref. 18). Since in the stability study, only very small values of θ and ϕ are involved, the tire characteristics for small slip and camber angles are outlined below (Ref. 17).

Up to about $1\frac{1}{2}^\circ$ slip angle, the cornering force varies linearly with slip angle and is independent of normal force.

Up to about $1\frac{1}{2}^\circ$ slip angle, aligning torque does vary linearly with slip angle, but is affected by the normal force, the greater the normal force the more is the aligning torque. The same is true for overturning moment due to slip up to about 1° of slip angle.

The lateral force, developed by camber at zero slip angle, is approximately a linear function of camber angle for

camber angles less than 5° . Change in lateral force even at 1° of camber angle can be perceived.

Aligning torque at zero slip varies linearly with camber angles up to about 3° . For large normal force, the aligning torque is independent of normal force at small camber angles. But for smaller normal force (of the order involved in a motorcycle), the aligning torque depends on normal force.

Overturning moment due to camber is a linear function of camber angle for camber angles less than 2° . Up to about 1° of camber angle, the normal force does not affect the overturning moment.

Assumptions

The slip and camber angles in the stability study are of the order of only a fraction of a degree. Therefore on the basis of the results of Ref. 17, as described above, all the tire forces and moments are assumed as linear function of slip and camber angles. For such parameters as are affected by normal force, interpolation has to be made to determine the suitable constants. Since the motorcycle tires are of smaller size than those tested on G. M. Tire Testing Machine, 75% of the forces and moments generated on G. M. tires can arbitrarily be taken as one representative set of figures for motorcycle tires. There is no practical data to justify this arbitrary value, but the fact that the solutions have been run for a range of such fractions, does cover all the tires possible. The objective is to work out a suitable and convenient method to include the tire effect and investigate the

qualitative correlation of analytical results with what was observed in the test runs on the road.

Another assumption is that the motorcycle tires are symmetrical. If there is a nonsymmetry in the tires, there will be lateral forces and moments even at zero slip and zero camber angles.

If λ is the slip angle and β the camber angle, the following linear relationships are assumed for very small values of λ and β .

Slip:

$$\text{Lateral force} = -\kappa_1 \lambda \quad [\text{lb}_f] \quad (2.1)$$

$$\text{Aligning torque} = +\kappa_2 \lambda \quad [\text{lb}_f\text{-ft}] \quad (2.2)$$

$$\text{Overturning moment} = +\kappa_3 \lambda \quad [\text{lb}_f\text{-ft}] \quad (2.3)$$

Camber:

$$\text{Lateral force} = +\kappa_4 \beta \quad [\text{lb}_f] \quad (2.4)$$

$$\text{Aligning torque} = +\kappa_5 \beta \quad [\text{lb}_f\text{-ft}] \quad (2.5)$$

$$\text{Overturning moment} = -\kappa_6 \beta \quad [\text{lb}_f\text{-ft}] \quad (2.6)$$

The sign conventions and tire force and moment configurations are shown in Fig. (2.1) and Fig. (2.2).

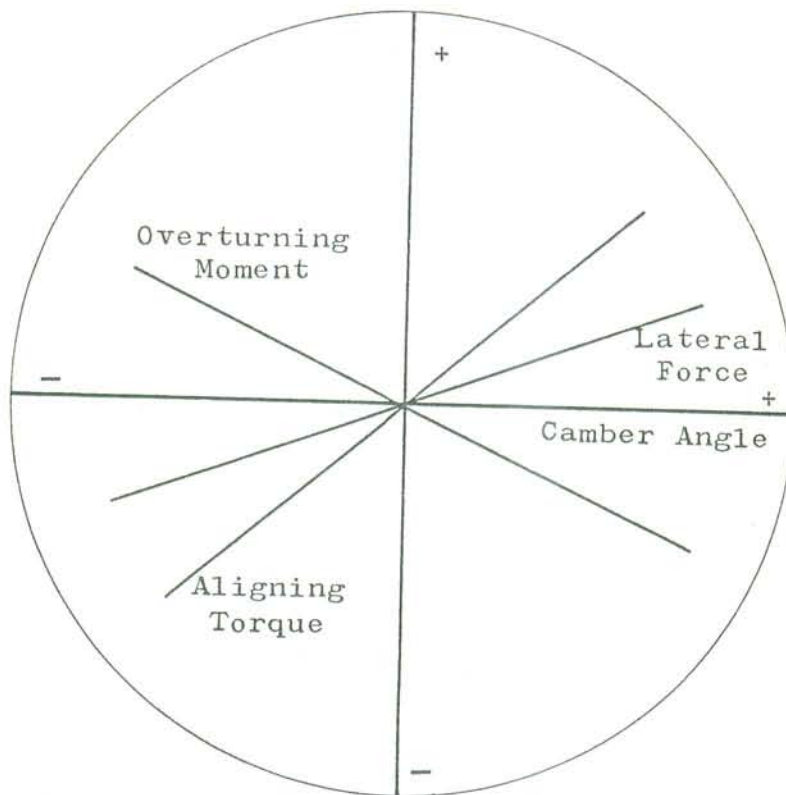
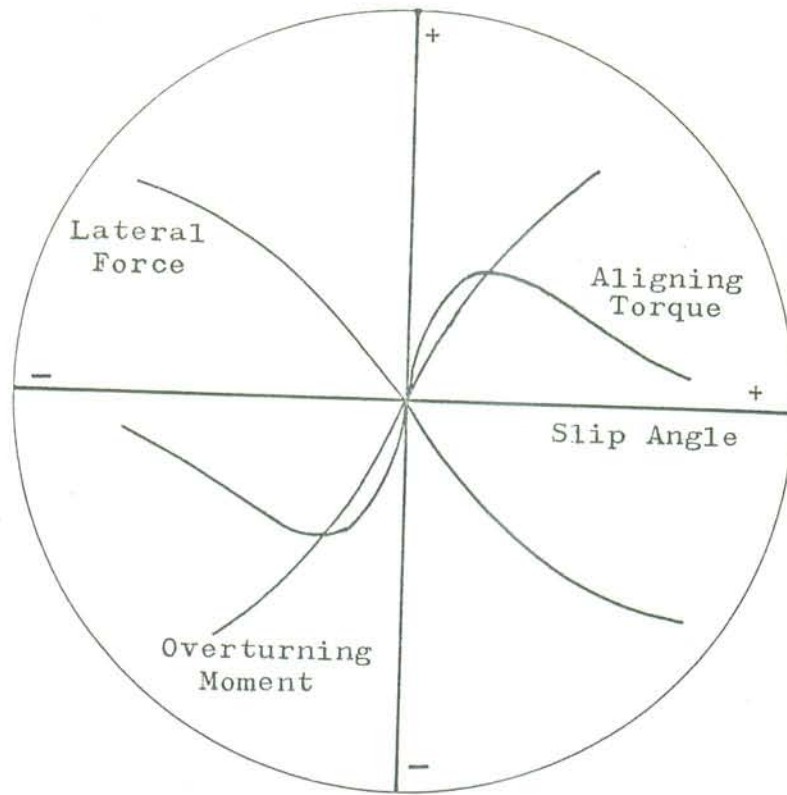

Fig. (2.1) SIGN CONVENTIONS

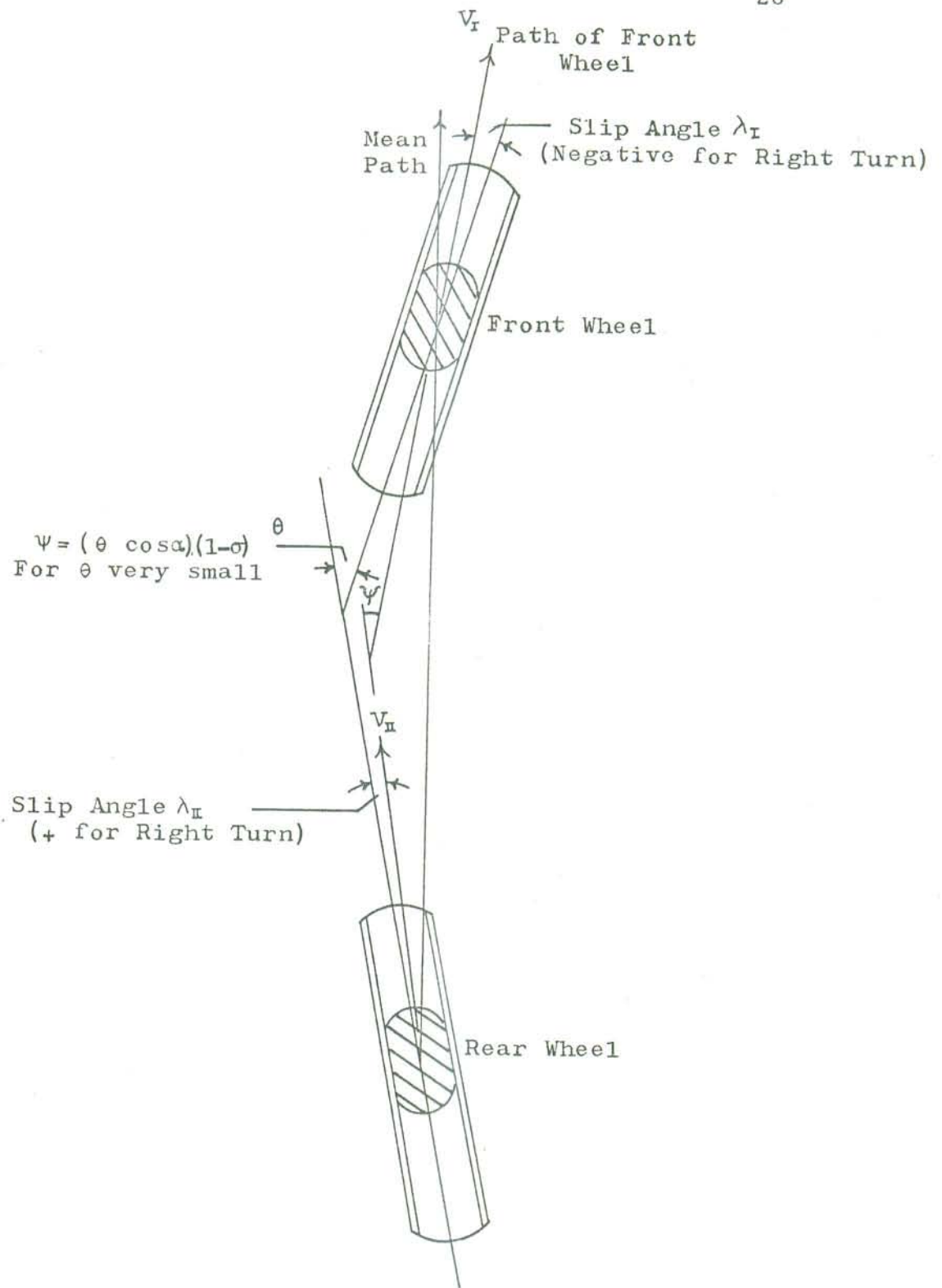

Fig.(2.2) SLIP CONFIGURATION
(Right Turn)

CHAPTER 3

MOTORCYCLE MOTION PHENOMENA

A stationary motorcycle, which is symmetrical about its longitudinal axis, if set upright and straight ahead, will stay as such as long as it is not disturbed by any outside force. But this is a very unstable equilibrium, since the slightest deviation from the critical upright position will result in the motorcycle falling down on its side under gravity. However, a motorcycle in motion does not fall flat, even when it is leaned to either side considerably. The force that balances the gravity, is the outward centrifugal force. A moving motorcycle continually experiences small disturbing forces from road irregularities, wind, inadvertent movement of rider, etc. These disturbances keep the motorcycle deviating from its upright position. If, while in motion, the motorcycle were as incapable of opposing gravity as it is when stationary, no amount of input from a rider sitting on the machine, either on steering or by shift of his weight, will keep the machine from falling over. But in motion, a motorcycle is capable of generating forces to keep itself upright.

The steering geometry of a motorcycle is such as to turn the front wheel in the direction of the fall, thus throwing the machine momentarily into a curve and developing a centrifugal force, which not only prevents the fall, but also restores the upright position.

If the centrifugal force acts longer than is required to straighten the motorcycle up, the motorcycle leans over on the other side. This will turn the front wheel in the new direction of fall and the machine goes momentarily into an opposite curve giving rise to a centrifugal force in opposite direction, again resisting the fall. In effect, the motorcycle behaves like an inverted pendulum. A stable motorcycle is the one which will oscillate with an ever-decreasing amplitude, and come to upright position after a finite number of oscillations.

The correct steering response is therefore the key to the stability of motorcycle. Steering response depends on a number of factors. If the driver effort is excluded, the forces and moments tending to turn the front wheel come from the road contact patch. In addition to the tire forces and moments, the gyroscopic effect of the rotating parts and moment of the gravitational components affect the steering response.

The input by the driver on the steering is to assist the steering response, a skill which is learned by practice. Consider a motorcycle which has neither a tendency to build up the oscillations nor to damp them out, or in other words, the motorcycle is acting like a pendulum. Also consider that the rider is rigidly connected to the rear system, and is applying no input to the steering bar. If this

machine is given only one slight disturbance, it will begin to oscillate at a constant amplitude. The oscillations will not die out, until the driver applies his corrective input on the handle bar and brings the machine back to steady upright motion. The machine can be brought to steady straight motion by any of innumerable possible inputs by the driver. The transient time will, of course, depend on the particular driver input. Different riders will react to the same situation differently and impose on the machine different inputs. Even the same driver is very unlikely to give identical inputs twice against the same disturbance. In an actual case, however, the motorcycle is not subjected to just one disturbance, it experiences continually, unknown disturbing forces of small magnitude. On such a machine, which has no tendency to damp the magnitude of the oscillation, the rider must constantly endeavor to damp out every disturbance the motorcycle experiences. And if the motorcycle is unstable, i. e., it has a tendency to build up the oscillation, the rider will find himself continually struggling to keep the machine under control. Only if the motorcycle is stable, will it absorb all the small disturbances with little or no driver effort. The fact that the disturbing forces under discussion are of very small magnitude, needs emphasis. No matter how stable a machine may be, it cannot sustain a strong disturbance say in the form of a hard push. Even a disturbance of finite magnitude, if applied at critical instants (resonant

pushes), will render the machine oscillate with ever-increasing amplitude. Therefore it is only with respect to small disturbing forces that the stability has any meaning. The important point is that the motorcycle should be capable to sustain the small disturbances and tend to damp the resulting oscillations out.

The center of mass of the front system is usually ahead of the steering axis. When the motorcycle leans, the moment due to gravity component normal to the plane of the front wheel tends to turn the front wheel in the direction of the lean. This moment is really a static moment independent of road speed. It acts as long as the machine is not vertical, and opposes the return of the front wheel to straight ahead direction even when the motorcycle starts to return to upright trim. It decreases with decrease in lean and becomes zero for the upright and straight ahead position of the motorcycle.

The gyroscopic effect of the rotating parts always imparts directional and attitude stability. This effect is shown by the diagrams of Fig. (3.1) and Fig. (3.2), for a motorcycle which has been disturbed and has sharply turned towards left. The diagrams indicate the chain of events illustrating the gyroscopic effect.

Tire forces and moments play an important role in establishing the resultant steering response. The directions of these forces and moments, resolved into the components parallel to body fixed axes of the two systems, are shown in the diagrams of Fig. (3.3).

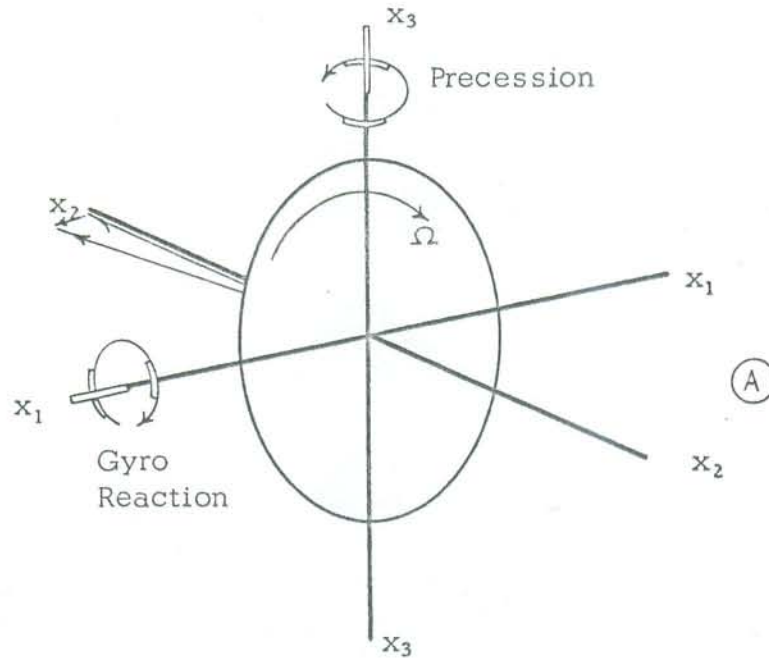

Fig. (3.1-a) Steering Turning Left, Precession (-) about x_3 -Axis, Gyro Reaction (+) on Front Wheel about x_1 -Axis.

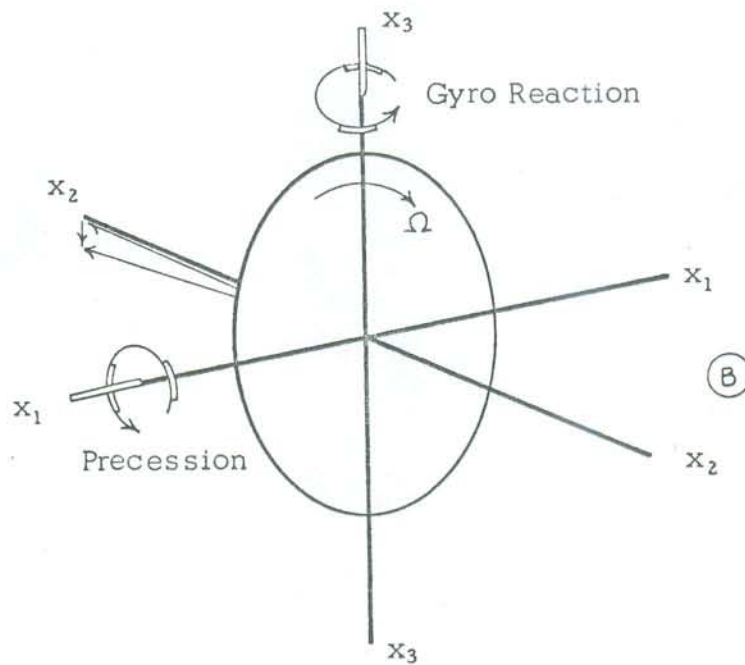

Fig. (3.1-b) Front Wheel Rolling, Precession (-) about x_1 -Axis, Gyro Reaction (-) about x_3 -Axis.

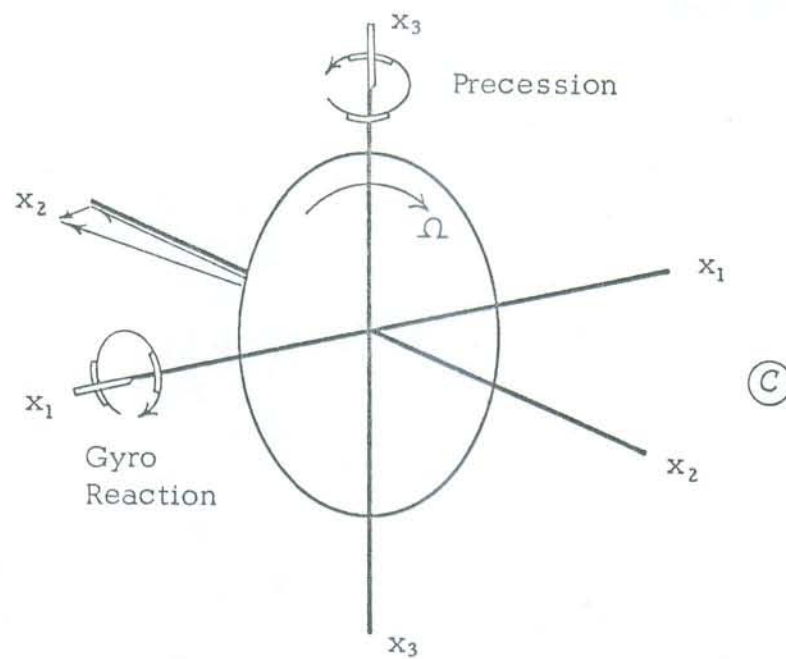

Fig. (3.1-c) Rear Wheel Precession (-) about x_3 -Axis,
Gyro Reaction (+) about x_1 -Axis.

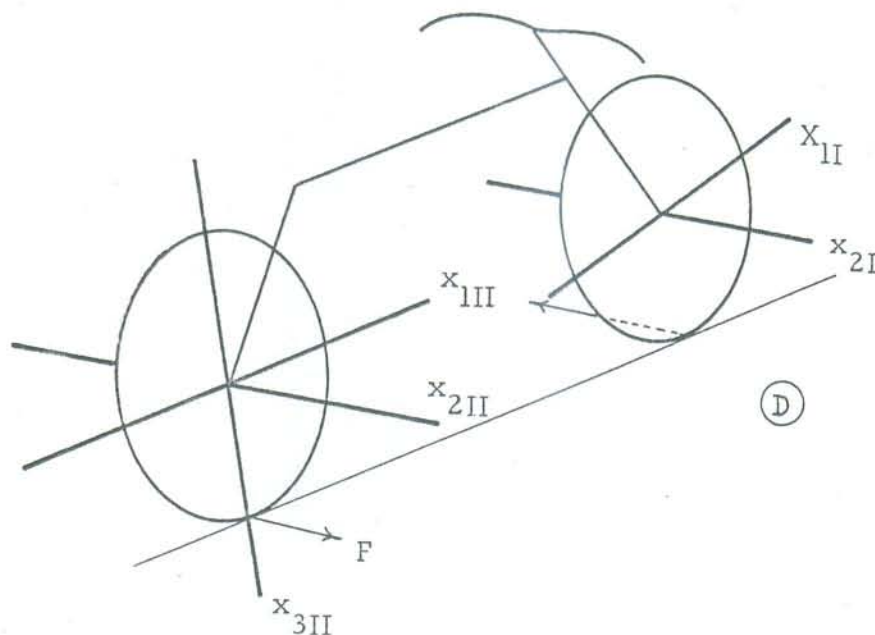

Fig. (3.1-d) Reaction at Front Wheel (-) Due to Gyro Reaction
about x_1 -Axis on Rear Wheel.

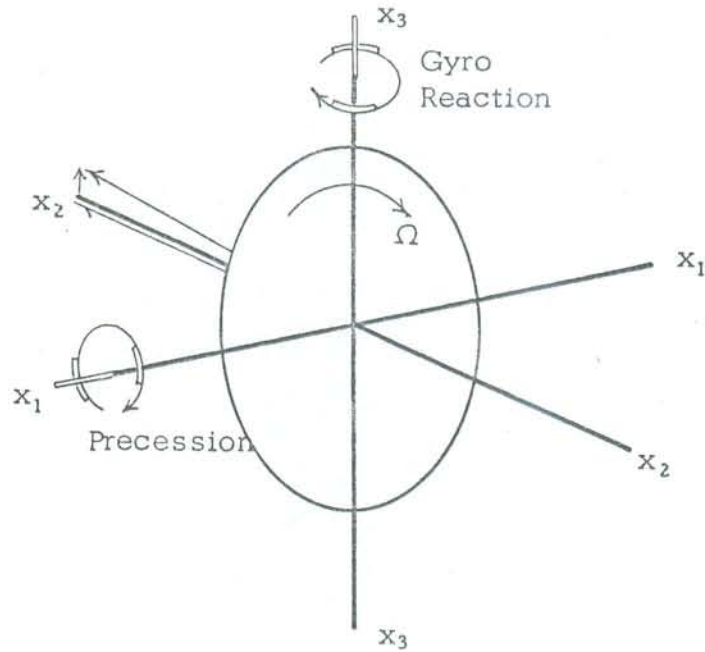

Fig. (3.2-a) Front Wheel Leaning Right, Precession about x_1 -Axis Tends to Turn the Wheel Towards Right by Creating Gyro Reaction about x_3 - Axis.

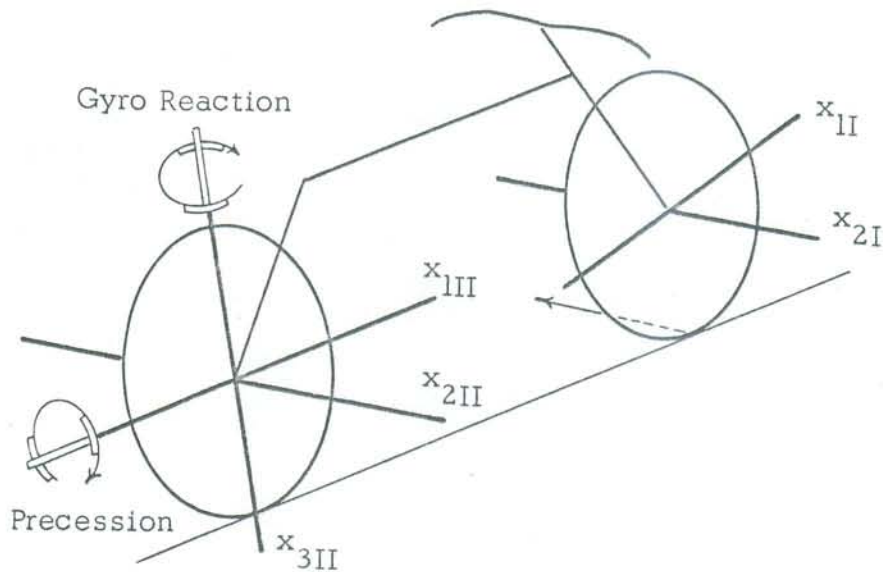

Fig. (3.2-b) Motorcycle Leaning Right, Gyro Reaction about x_3 -Axis on Rear Wheel, Reaction at Contact Point of Front Wheel Directed Left.

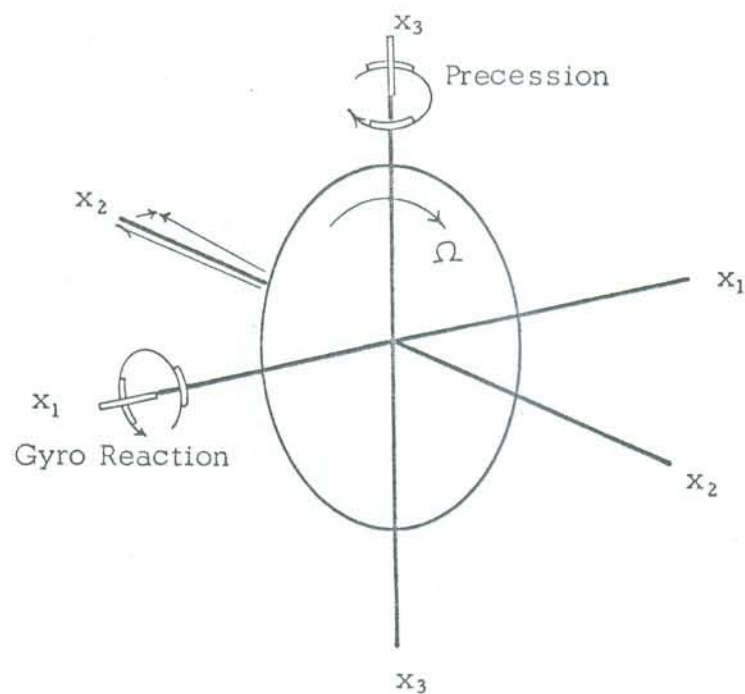

Fig. (3.2-c) Steering Turning Right, Precession About x_3 -Axis, Gyro Reaction about x_1 -Axis Both Wheels

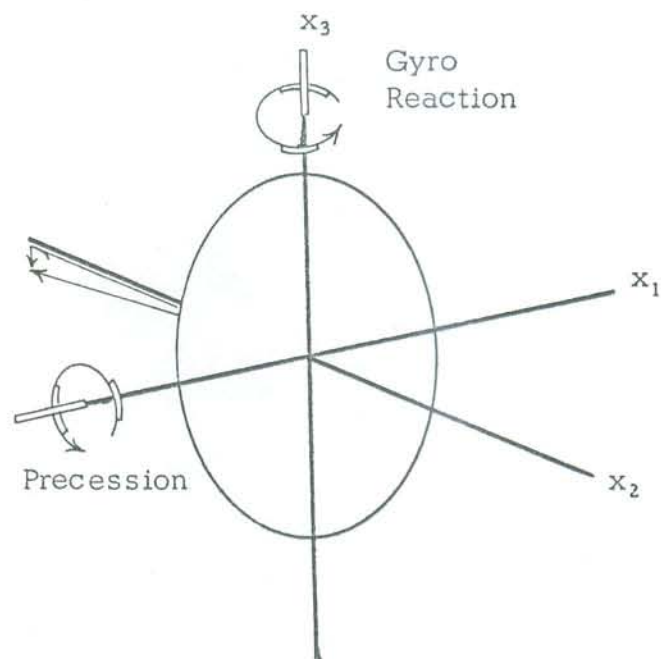

Fig. (3.2-d) Front Wheel Returning Upright, Precession About x_1 -Axis, Gyro Reaction About x_3 -Axis Tends to Turn the Wheel Left Back to Straight Ahead Position.

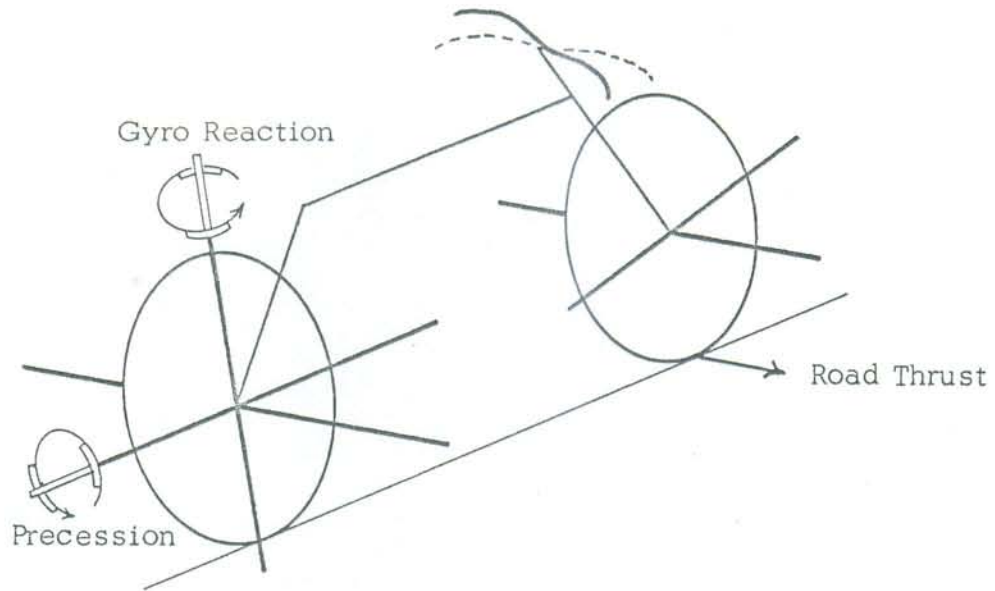

Fig. (3.2-e) Returning Upright, Reaction on Contact Point of Front Wheel With Road Directed to the Right.

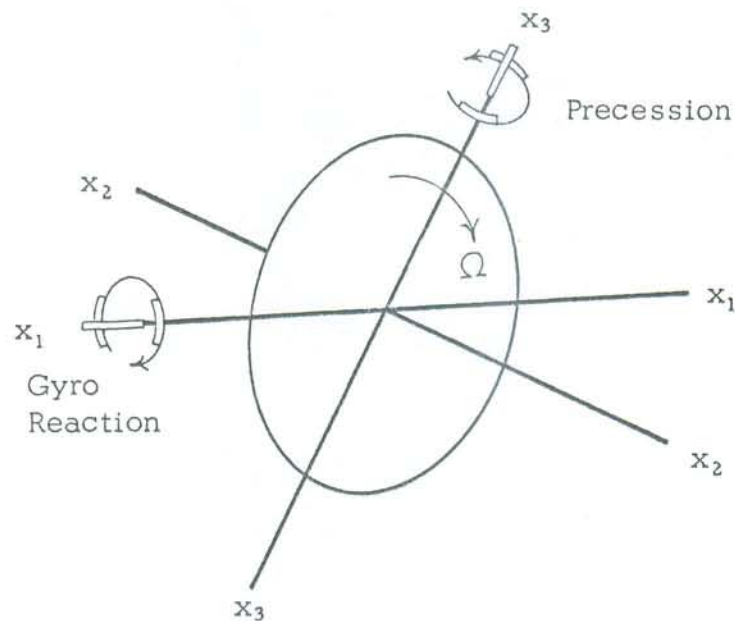

Fig. (3.2-f) Steering Turning Left, Precession About x_3 -Axis, Gyro Reaction About x_1 -Axes on Both Wheels

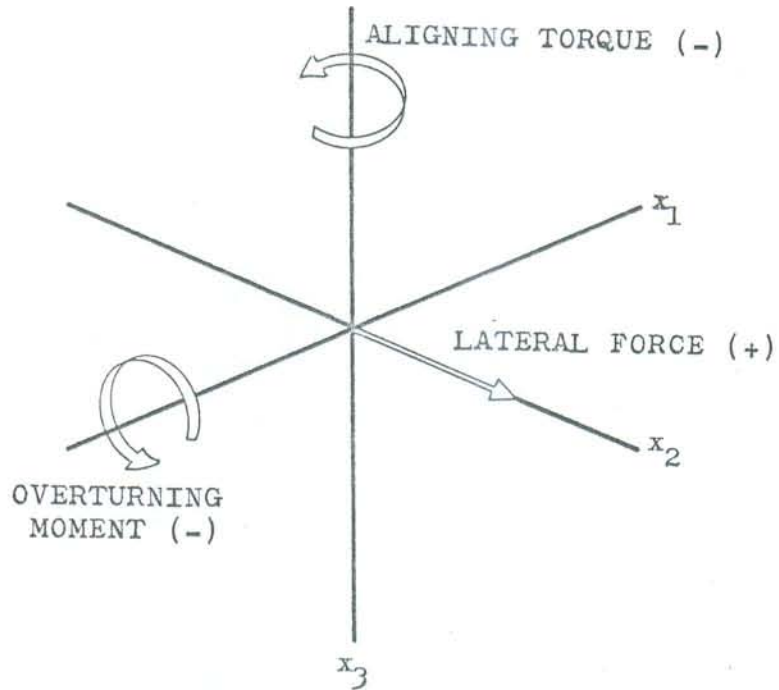

Fig. (3.3-a) Tire Forces and Moments
Slip - Front Tire
Right Turn and Right Lean

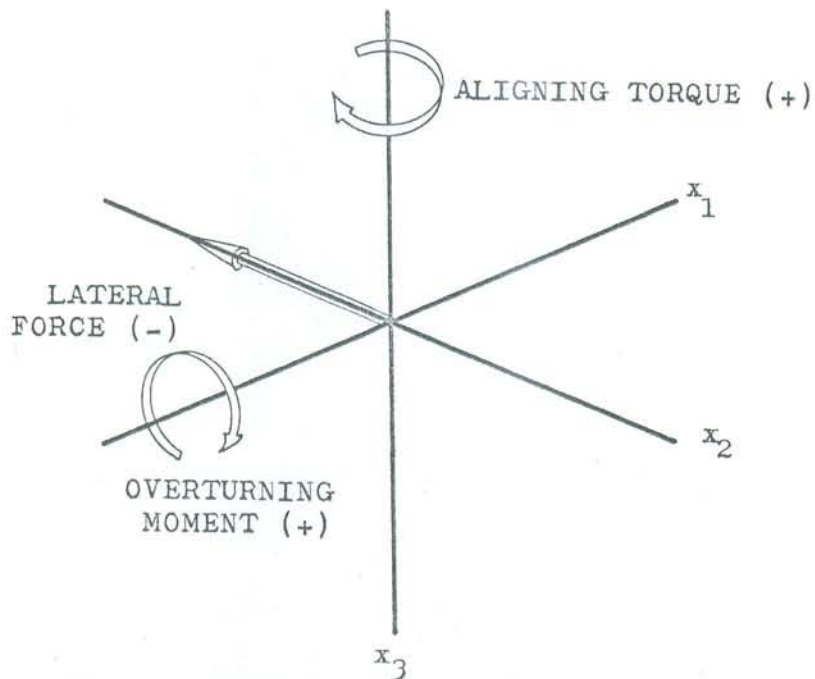

Fig. (3.3-b) Tire Forces and Moments
Slip - Rear Wheel
Right Turn and Right Lean

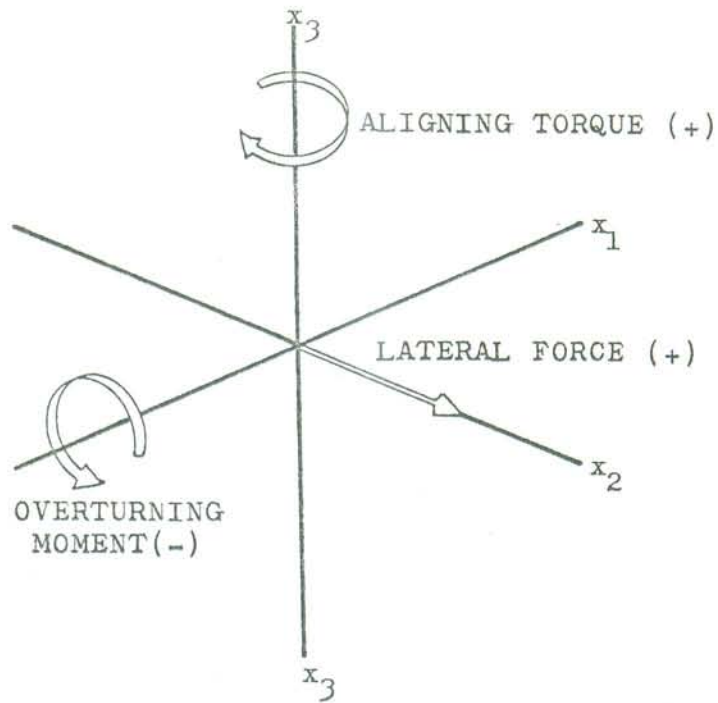
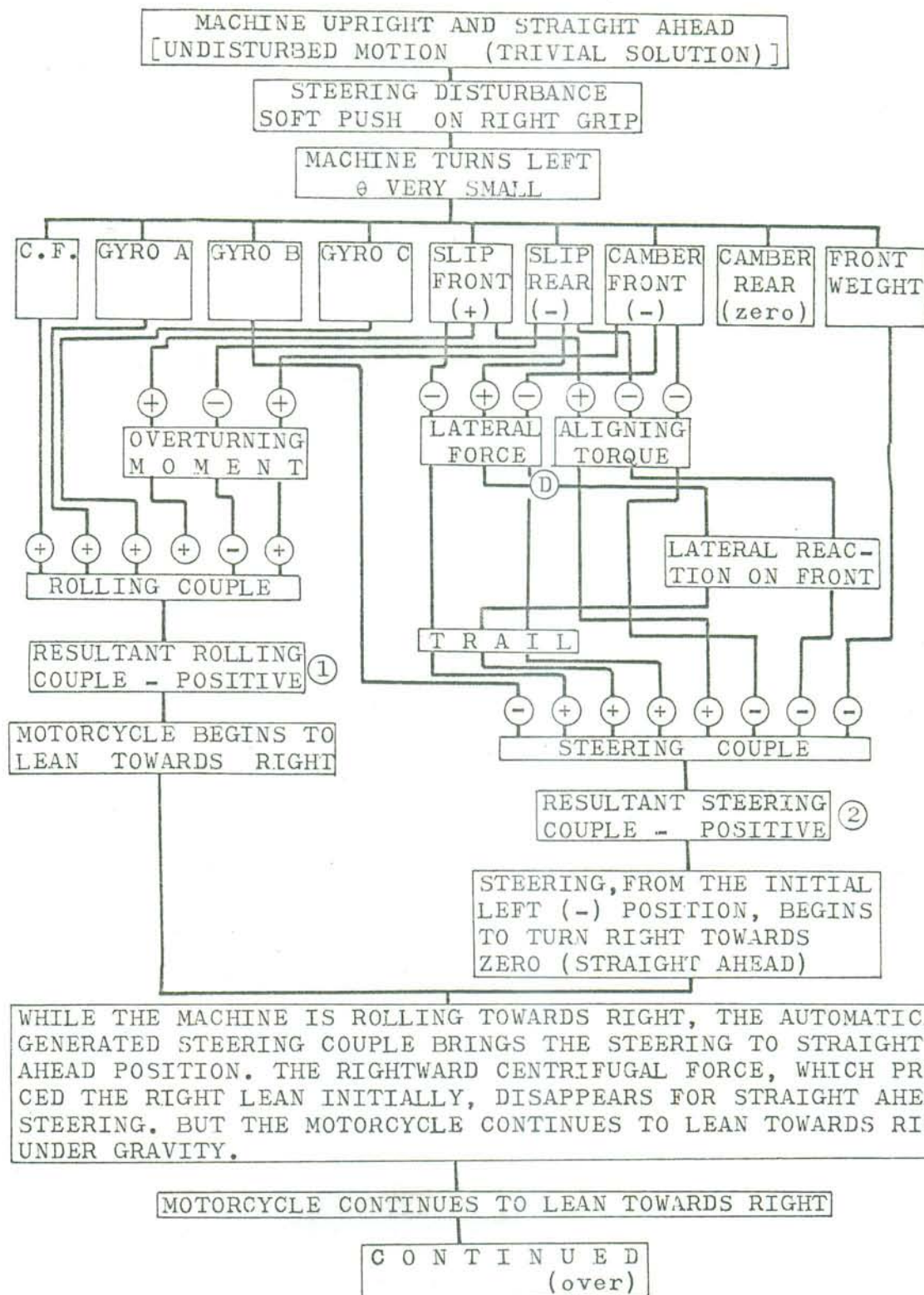
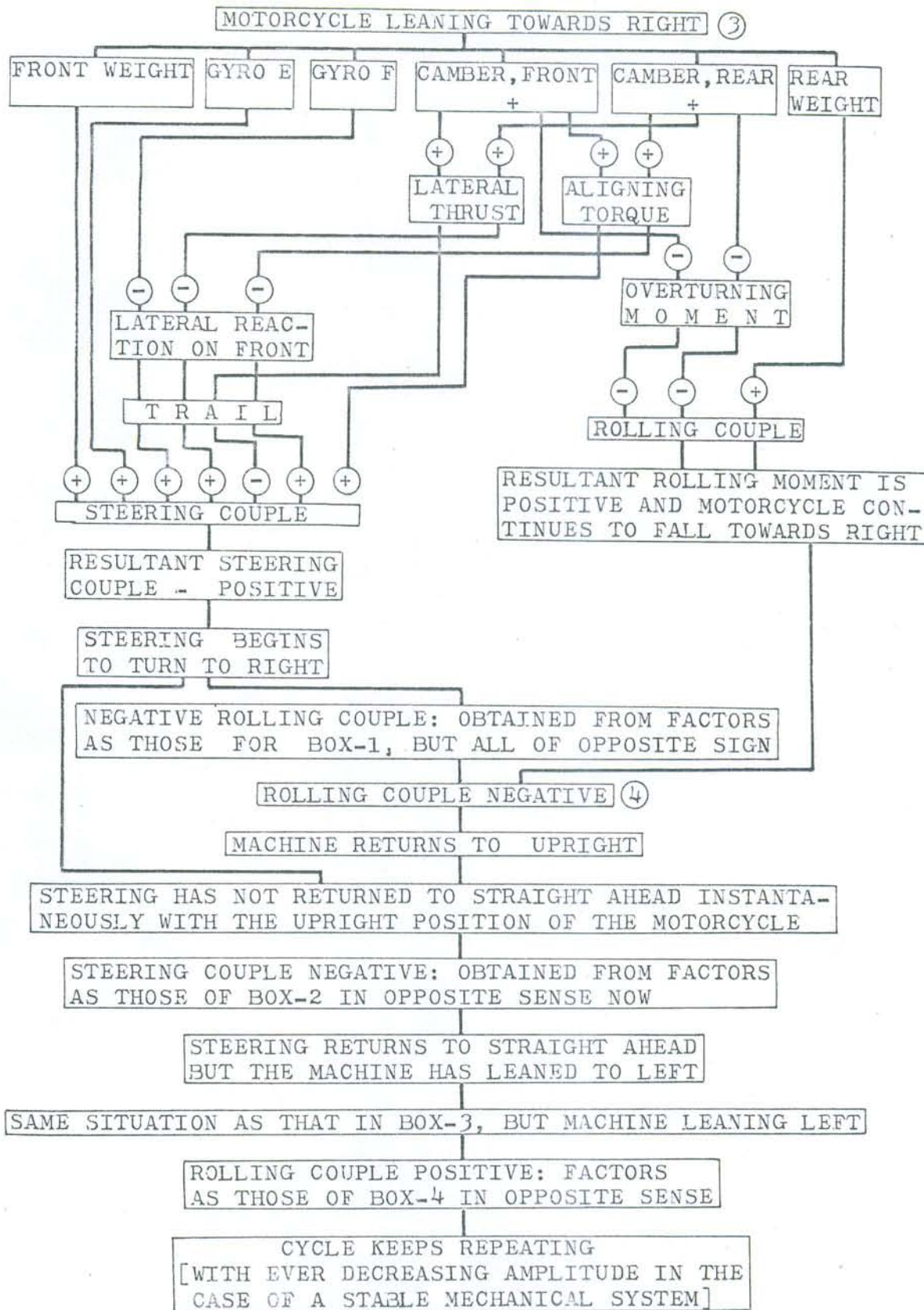

Fig. (3.3-c) Tire Forces and Moments
 Camber - Both Wheels
 Right Lean and Right Turn

Wilson-Jones (Ref. 22) used a method of block diagrams to explain the mechanism of motorcycle motion. A modified and more comprehensive block diagram, including all the factors affecting the stability, is given herewith to explain the rather intricate motorcycle motion phenomena. This would be very difficult to explain in any other manner.



C.F.: Centrifugal Force



CHAPTER 4

EXTERNAL FORCES AND MOMENTS

Basic Variables

Strictly speaking, five coordinates are necessary to completely describe the position of a motorcycle. Two coordinates establish the point of contact of rear wheel, two angles give the angle of the plane of the rear wheel, and one coordinate determines the angle between the frame and the front wheel. An additional requirement is that both wheels must always remain in contact with ground. With five degrees of positional freedom, the vehicle has only three degrees of freedom of motion. They are (i) lean of the frame (roll), (ii) rotation of the hinged part about the steering axis, and (iii) the forward motion, whose direction has already been determined by the position of the front wheel. The motion is nonholonomic.

The stability consideration is for a straight travel which essentially means that the average path of the two wheels is straight and the actual paths of both wheels are very close to the average path. Therefore, two space coordinates locating the rear wheel are incorporeal. In other words, it does not matter as to where on the road the motorcycle is located at any given instant. The two angles needed to describe the rear wheel may be ϕ and the rotation about x_{3II} -axis. The rotation of rear wheel about x_{3II} -axis is negligible.

Hence two angles θ and ϕ are adequate to completely describe the position of a two-wheeled vehicle for stability study. It is in terms of these two variables that the final equations have been established.

Sign Conventions and Basic Assumptions

x_3 direction is taken as positive downwards in the direction of gravity force and right-handed orthogonal system is taken as the coordinate system, Fig. (4.1).

The motorcycle is assumed to be made up of two connected physical systems. The front system is made up of the mass which rotates about the steering axis with respect to the remaining mass in the rear. This remaining mass is the rear system. The two systems are supposed to be connected at an imaginary separation point which is in equilibrium. The origins of the body fixed right-handed orthogonal axes of the two systems are their centers of gravity respectively.

Right-handed screw rotation is considered positive and is denoted by a vector normal to the plane of rotation. Although the addition of two rotations corresponds to the product of two matrices, which is not commutative, the rotation vectors are considered commutative since only very small rotations are involved in the motion for investigating the stability.

Rigid Body Motion

If \bar{r}_s be the position vector of an elementary mass δm of a rigid body relative to an arbitrary space fixed orthogonal axes system, and if m be the total mass of the body with \bar{r} the position vector of its center of gravity, the following relation can be written

$$m \bar{r} = \sum \delta m \bar{r}_s \quad (4.1)$$

Let \bar{F}_s be the force acting on the element of mass δm , then

$$\delta m \ddot{\bar{r}}_s = \bar{F}_s \quad (4.2)$$

Summation for all the elements of mass gives

$$\sum \delta m \ddot{\bar{r}}_s = \sum \bar{F}_s \quad (4.3)$$

$$\text{or} \quad m \ddot{\bar{r}} = \bar{F} \quad (4.4)$$

where \bar{F} is the external force acting on the body. The internal forces vanish in the summation.

The following relationships hold for the moment of momentum about the origin

$$\frac{d}{d\tau} (\bar{r}_s \times \delta m \dot{\bar{r}}_s) = \bar{r}_s \times \bar{F}_s \quad (4.5)$$

and

$$\frac{d}{d\tau} (\sum (\bar{r}_s \times \delta m \dot{\bar{r}}_s)) = \sum (\bar{r}_s \times \bar{F}_s) \quad (4.6)$$

In the summation of moments of forces, the internal forces vanish, and therefore the rate of change of total angular momentum about the origin is equal to the total moment of the external forces about the origin.

$$\text{Let } \bar{r}_s = \bar{r} + \bar{\rho}_s \quad (4.7)$$

so that $\bar{\rho}_s$ is the position vector of element δm with respect to the center of gravity, and also by the definition of center of gravity $\sum \delta m \bar{\rho}_s = 0$. Then

$$\begin{aligned} \frac{d}{d\tau} \sum (\bar{r}_s \times \delta m \dot{\bar{r}}_s) &= \frac{d}{d\tau} (\sum \delta m (\bar{r} + \bar{\rho}_s) \times (\dot{\bar{r}} + \dot{\bar{\rho}}_s)) \\ &= \frac{d}{d\tau} (m\bar{r} \times \dot{\bar{r}} + \bar{r} \times \sum \delta m \dot{\bar{\rho}}_s \\ &\quad (\sum \delta m \bar{\rho}_s) \times \dot{\bar{r}} + \sum (\delta m \bar{\rho}_s \times \dot{\bar{\rho}}_s)) \\ &= m\bar{r} \times \ddot{\bar{r}} + \frac{d}{dt} \sum (\delta m \bar{\rho}_s \times \dot{\bar{\rho}}_s) \end{aligned}$$

and

$$\begin{aligned} \sum (\bar{r}_s \times \bar{F}_s) &= \sum (\bar{r} \times \bar{F}_s + \bar{\rho}_s \times \bar{F}_s) \\ &= \bar{r} \times \sum \bar{F}_s + \sum (\bar{\rho}_s \times \bar{F}_s) \\ &= \bar{r} \times m\ddot{\bar{r}} + \sum (\bar{\rho}_s \times \bar{F}_s) \end{aligned}$$

Therefore

$$\frac{d}{d\tau} \sum (\delta m \bar{\rho}_s \times \dot{\bar{\rho}}_s) = \sum (\bar{\rho}_s \times \bar{F}_s) \quad (4.8)$$

The motion relative to the center of gravity may be represented by a rotation vector $\bar{\omega} = \bar{i}\omega_1 + \bar{j}\omega_2 + \bar{k}\omega_3$ through the center of gravity, then

$$\dot{\bar{\rho}}_s = \bar{\omega} \times \bar{\rho}_s \quad (4.9)$$

Since orientation of space fixed orthogonal axes is arbitrary, the space fixed axes can be assumed to be parallel to the body fixed axes instantaneously. The angular momentum \bar{L} about the

center of gravity can then be expressed as

$$\begin{aligned}\bar{L} &= \Sigma(\delta m \bar{\rho}_S \times \dot{\bar{\rho}}_S) \\ &= \Sigma(\delta m \bar{\rho}_S \times (\bar{\omega} \times \bar{\rho}_S))\end{aligned}$$

or, expanding the triple cross product

$$\bar{L} = \bar{\omega} \Sigma \delta m \rho_S^2 - \Sigma \delta m (\bar{\rho}_S \cdot \bar{\omega}) \bar{\rho}_S \quad (4.10)$$

If $\bar{\rho}_S = \bar{i} \xi_S + \bar{j} \eta_S + \bar{k} \zeta_S$, then

$$\begin{aligned}\bar{L} &= \bar{\omega} \Sigma \delta m (\xi_S^2 + \eta_S^2 + \zeta_S^2) \\ &\quad - \Sigma \delta m (\xi_S \omega_1 + \eta_S \omega_2 + \zeta_S \omega_3) (\bar{i} \xi_S + \bar{j} \eta_S + \bar{k} \zeta_S) \\ &= \bar{i} L_1 + \bar{j} L_2 + \bar{k} L_3\end{aligned} \quad (4.11)$$

where

$$L_1 = I_{11} \omega_1 + I_{12} \omega_2 + I_{13} \omega_3 \quad (4.12-a)$$

$$L_2 = I_{21} \omega_1 + I_{22} \omega_2 + I_{23} \omega_3 \quad (4.12-b)$$

$$L_3 = I_{31} \omega_1 + I_{32} \omega_2 + I_{33} \omega_3 \quad (4.12-c)$$

The nine coefficients I_{11} , I_{12} , etc., are nine elements of transformation matrix. The diagonal elements are familiar as moment of inertia and the off diagonal elements as product of inertia. They are

$$I_{11} = \Sigma \delta m (\eta_S^2 + \zeta_S^2) \quad (4.13-a)$$

$$I_{22} = \Sigma \delta m (\zeta_S^2 + \xi_S^2) \quad (4.13-b)$$

$$I_{33} = \Sigma \delta m (\xi_S^2 + \eta_S^2) \quad (4.13-c)$$

$$I_{12} = I_{21} = - \Sigma \delta m \xi_S \eta_S \quad (4.13-d)$$

$$I_{23} = I_{32} = -\sum \delta m \eta_s \zeta_s \quad (4.13-e)$$

$$I_{31} = I_{13} = -\sum \delta m \zeta_s \xi_s \quad (4.13-f)$$

Due to symmetry of the motorcycle, four of the products of inertia are zero.

$$I_{12} = I_{21} = I_{23} = I_{32} = 0 \quad (4.14)$$

Since the body fixed axes themselves are rotating with angular velocity $\bar{\omega}$, the external moment is

$$\begin{aligned} \bar{M} &= \frac{d\bar{L}}{d\tau} + \bar{\omega} \times \bar{L} \\ &= \bar{i} \dot{L}_1 + \bar{j} \dot{L}_2 + \bar{k} \dot{L}_3 + \bar{\omega} \times \bar{L} \end{aligned} \quad (4.15)$$

and the components are

$$M_1 = \dot{L}_1 + \omega_2 L_3 - \omega_3 L_2 \quad (4.16-a)$$

$$M_2 = \dot{L}_2 + \omega_3 L_1 - \omega_1 L_3 \quad (4.16-b)$$

$$M_3 = \dot{L}_3 + \omega_1 L_2 - \omega_2 L_1 \quad (4.16-c)$$

The three components can be written in one compact form

$$M_i = \dot{L}_i + \omega_j L_k - \omega_k L_j \quad (4.17)$$

Rotating Parts

A motorcycle has rotating parts which contribute to the angular momentum. The angular momentum due to rotating parts can be expediently regarded as due to an imaginary equivalent rigid body whose angular momentum has two zero components and whose third component is $I'\bar{\Omega}$, where I' is the equivalent moment of inertia and $\bar{\Omega}$ the

angular velocity of the rear wheel. The equations derived above are valid for this rigid body also, and the external moment will be equal to the sum of the time rate of change of the two angular momenta. Using prime notations for the angular momentum terms of the imaginary body, the components of external moment are

$$M_i = \dot{L}'_i + \omega_j L'_{jk} - \omega_k L'_{kj} + \dot{L}'_i + \omega_j L'_{jk} - \omega_k L'_{kj} \quad (4.18)$$

For the imaginary rigid body

$$L'_1 = 0, \quad L'_3 = 0 \quad (4.19)$$

and therefore their time derivatives

$$\dot{L}'_1 = \dot{L}'_3 = 0 \quad (4.20)$$

The third component is

$$L'_2 = I'\Omega \quad (4.21)$$

and its derivative is

$$\dot{L}'_2 = I'\dot{\Omega} = 0 \quad (4.22)$$

since the stability analysis presumes that the motorcycle is traveling at constant speed in very near straight ahead and upright position.

Moment Components

The three moment components can finally be written from equations (4.16) and equations (4.18) through (4.22).

$$M_1 = \dot{L}_1 + \omega_2 L_3 - \omega_3 L_2 - \omega_3 I'\Omega \quad (4.23-a)$$

$$M_2 = \dot{L}_2 + \omega_3 L_1 - \omega_1 L_3 \quad (4.23-b)$$

$$M_3 = \dot{L}_3 + \omega_1 L_2 - \omega_2 L_1 + \omega_3 I'\Omega \quad (4.23-c)$$

Equations (4.12) and their time derivatives along with equations (4.23) give

$$M_1 = I_{11}\dot{\omega}_1 - (I_{22} - I_{23})\omega_2\omega_3 + I_{13}(\dot{\omega}_3 + \omega_1\omega_2) - I'\Omega\omega_3 \quad (4.24-a)$$

$$M_2 = I_{22}\dot{\omega}_2 - (I_{33} - I_{11})\omega_3\omega_1 + I_{13}(\omega_3^2 - \omega_1^2) \quad (4.24-b)$$

$$M_3 = I_{33}\dot{\omega}_3 - (I_{11} - I_{22})\omega_1\omega_2 + I_{13}(\dot{\omega}_1 - \omega_2\omega_3) + I'\Omega\omega_1 \quad (4.24-c)$$

Force Components

Taking into account the rotation of the body, the translational acceleration vector may be written as

$$\bar{a} = \dot{\bar{v}} + \bar{\omega} \times \bar{v} \quad (4.25)$$

The components of the acceleration are

$$a_1 = \dot{v}_1 + \omega_2 v_3 - \omega_3 v_2 \quad (4.26-a)$$

$$a_2 = \dot{v}_2 + \omega_3 v_1 - \omega_1 v_3 \quad (4.26-b)$$

$$a_3 = \dot{v}_3 + \omega_1 v_2 - \omega_2 v_1 \quad (4.26-c)$$

or, in compact form, these components are

$$a_i = \dot{v}_i + \omega_j v_k - \omega_k v_j \quad (4.27)$$

The three components of external forces are

$$F_i = m(\dot{v}_i + \omega_j v_k - \omega_k v_j) \quad (4.28)$$

Rotational Components and Slip

If there is no slip for tires in Fig. (2.2), the angle between the path of the front and rear wheels is given by the following trigonometrical relation,

$$\tan\psi = \frac{\cos\alpha}{\cos\phi \cot\theta - \sin\phi \sin\theta} \quad (4.29)$$

In the close neighborhood of upright and straight ahead position of the motorcycle, in which the stability has been investigated, both ϕ and θ are very small. Therefore the following approximation is valid

$$\psi = \theta \cos\alpha \quad (4.30)$$

Before introducing the slip term, some assumptions are necessary. It seems quite logical to assume that for perfectly upright and straight ahead position of the motorcycle, i. e., for absolutely straight travel, the slip is zero on both the wheels. When the handle bar is turned, slip appears since the path of the front wheel is not described by the geometrical intersection of the plane of the wheel and the ground. The same is true for the rear wheel as well. Slip, λ , the angle between the path of the wheel and the geometrical intersection of the plane of the wheel with the ground, is zero when θ is zero and increases as θ increases. It is assumed that for very small values of θ involved in the stability study, the slip varies linearly as θ . This assumption may, at the first glance, appear quite arbitrary. But the implication of this assumption, that the cornering force for small values of θ will vary linearly with θ , seems to support its validity. The slip will therefore be expressed as a fraction σ of the steering angle θ . The following relation for ψ can thus be written,

$$\psi = (1 - \sigma)\theta \cos\alpha \quad (4.31)$$

where the total slip is $\sigma\theta \cos\alpha$.

The use of the term "total slip" is intended to signify that slip is present at both, the front and the rear wheels. If λ_I and λ_{II} are the slip angles of the front and rear wheels respectively

$$|\lambda_I| + |\lambda_{II}| = \sigma\theta \cos\alpha \quad (4.32)$$

The major portion of the total slip will be on the front wheel.

Assuming for the front wheel

$$\lambda_I = z(\sigma\theta \cos\alpha) \quad (4.33)$$

the slip on the rear wheel will be

$$\lambda_{II} = (1-z)(\sigma\theta \cos\alpha) \quad (4.34)$$

There is no way to determine experimentally the value of z (and even σ) accurately for various motorcycle situations. A typical value of z may arbitrarily be .75 implying that 75% of the total slip occurs at the front wheel. The solutions have been run for a range of values of z and for various values of σ .

Another assumption made in establishing the equations is that the contact patch of the front tire does not move laterally, since θ involved is very small.

Referring to Fig. (2.2)

$$v_{II} = v_I \cos\psi \cong -r_{II}\Omega_{II}$$

and

$$v_I = -r_I\Omega_I$$

Therefore

$$\Omega_I = \frac{r_{II}}{r_I} \frac{\Omega_{II}}{\cos\psi} \quad (4.35)$$

The angular velocity of the rear system about a vertical line is

$$\omega_v = \frac{v_I \sin\psi}{R} = \frac{-r_{II} \Omega_{II}}{R} \tan\psi \quad (4.36)$$

The angular velocity components for system II are therefore

$$\omega_{1 II} = + \dot{\phi} \quad (4.37-a)$$

$$\omega_{2 II} = + \omega_v \sin\phi = - \frac{r_{II}}{R} \Omega_{II} \tan\psi \sin\phi \quad (4.37-b)$$

$$\omega_{3 II} = + \omega_v \cos\phi = - \frac{r_{II}}{R} \Omega_{II} \tan\psi \cos\phi \quad (4.37-c)$$

Since the two wheels are of the same size, $r_I = r_{II}$ and both r_I and r_{II} are replaced by r . Also, since Ω_I will be expressed in terms of Ω_{II} , the subscript "II" may be dropped henceforth and " Ω " may represent the angular velocity of the rear wheel. So, the components of the angular velocity vector of the rear body-system are

$$\omega_{1 II} = \dot{\phi} \quad (4.38-a)$$

$$\omega_{2 II} = - \frac{r}{R} \Omega \tan\psi \sin\phi \quad (4.38-b)$$

$$\omega_{3 II} = - \frac{r}{R} \Omega \tan\psi \cos\phi \quad (4.38-c)$$

The angular velocity vector of the front body-system will be equal to the angular velocity of the rear system $\vec{\omega}_{II}$ plus the angular velocity of steering rotation. The angular velocity of the rear system can be resolved into components parallel to the body fixed axes of the front system.

The transformation matrix is

$$\begin{vmatrix} \cos\alpha \cos\theta & \sin\theta & -\sin\alpha \cos\theta \\ -\cos\alpha \sin\theta & \cos\theta & \sin\alpha \sin\theta \\ \sin\alpha & 0 & \cos\alpha \end{vmatrix}$$

and the angular velocity components of the front system are

$$\omega_{1I} = \dot{\phi} \cos\alpha \cos\theta - \frac{r}{R} \Omega \tan\psi (\sin\phi \sin\theta - \cos\phi \sin\alpha \cos\theta) \quad (4.39-a)$$

$$\omega_{2I} = -\dot{\phi} \cos\alpha \sin\theta - \frac{r}{R} \Omega \tan\psi (\sin\phi \cos\theta + \cos\phi \sin\alpha \sin\theta) \quad (4.39-b)$$

$$\omega_{3I} = \dot{\phi} \sin\alpha - \frac{r}{R} \Omega \tan\psi \cos\phi \cos\alpha + \dot{\theta} \quad (4.39-c)$$

Translational Components

Referring to Fig. (4.1) the following relations can be written for the rear system

$$\begin{aligned} v_{1II} &= -r\Omega - \omega_{2II} a_{II} \\ &= -r\Omega + \frac{r}{R} \Omega a_{II} \tan\psi \sin\phi \end{aligned} \quad (4.40-a)$$

$$\begin{aligned} v_{2II} &= h_{II} \dot{\phi} + a_{II} \omega_{3II} \\ &= h_{II} \dot{\phi} - a_{II} \frac{r}{R} \Omega \tan\psi \cos\phi \end{aligned} \quad (4.40-b)$$

$$\begin{aligned} v_{3II} &= -a_{II} \omega_{2II} \\ &= a_{II} \frac{r}{R} \Omega \tan\psi \sin\phi \end{aligned} \quad (4.40-c)$$

and for the front system

$$\begin{aligned} V_{1I} &= v_{1II} \frac{\cos\alpha}{\cos\psi} - h_I \omega_{2I} \\ &= r\Omega \frac{\cos\alpha}{\cos\psi} \left(-1 + \frac{a_{II}}{R} \tan\psi \sin\phi\right) + h_I (\cos\alpha \sin\theta \dot{\phi}) \end{aligned} \quad (4.41-a)$$

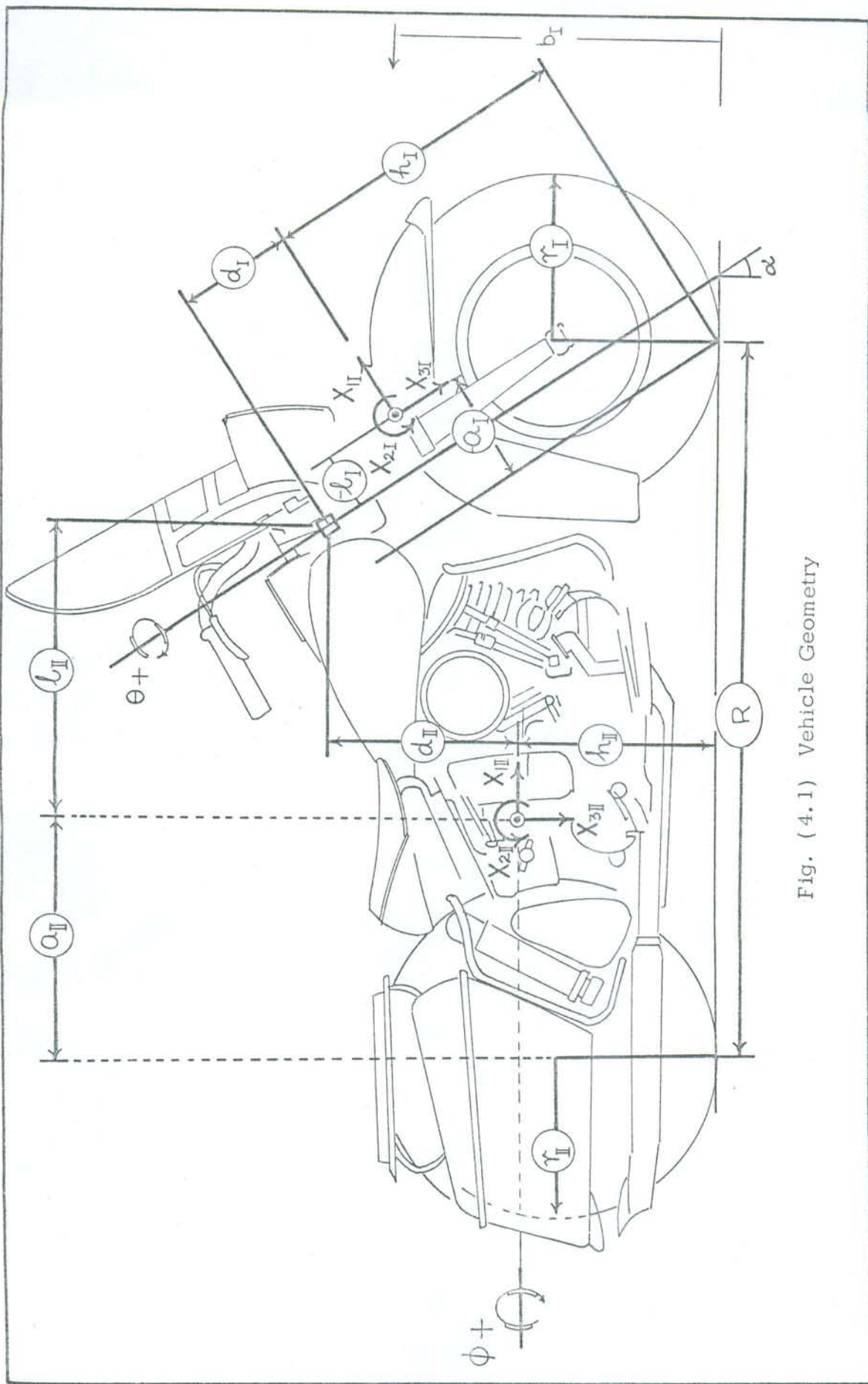

Fig. (4.1) Vehicle Geometry

$$+ \frac{r}{R} \Omega \tan\psi (\sin\phi \cos\theta - \cos\phi \sin\alpha \cos\theta) \quad (4.41-a)$$

(cont.)

$$\begin{aligned} v_{2I} &= -a_I \omega_{3I} + h_I \omega_{1I} \\ &= -a_I (\dot{\phi} \sin\alpha - \frac{r}{R} \Omega \tan\psi \cos\phi \cos\alpha + \dot{\theta}) \\ &\quad + h_I (\dot{\phi} \cos\alpha \cos\theta - \frac{r}{R} \Omega \tan\psi (\sin\phi \sin\theta - \cos\phi \sin\alpha \cos\theta)) \end{aligned} \quad (4.41-b)$$

$$\begin{aligned} v_{3I} &= -r\Omega \frac{\sin\alpha}{\cos\psi} + a_I \omega_{2I} \\ &= -r\Omega \frac{\sin\alpha}{\cos\psi} - a_I (\dot{\phi} \cos\alpha \sin\theta + \frac{r}{R} \Omega \tan\psi (\sin\phi \cos\theta \\ &\quad + \cos\phi \sin\alpha \sin\theta)) \end{aligned} \quad (4.41-c)$$

Angular Acceleration Components

Equations (4.39) and (4.38) may be differentiated with respect to time to give the angular acceleration components of the two body-systems.

$$\begin{aligned} \dot{\omega}_{1I} &= \cos\alpha (\cos\theta \ddot{\phi} - \sin\theta \dot{\phi} \dot{\theta}) - \frac{r}{R} \Omega (\sec^2\psi \sin\phi \sin\theta \dot{\psi} \\ &\quad + \tan\psi (\cos\phi \sin\theta \dot{\phi} + \sin\phi \cos\theta \dot{\theta}) \\ &\quad - \sin\alpha (\sec^2\psi \cos\phi \cos\theta \dot{\psi} - \tan\psi (\sin\phi \cos\theta \dot{\phi} \\ &\quad + \cos\phi \sin\theta \dot{\theta})) \end{aligned} \quad (4.42-a)$$

$$\begin{aligned} \dot{\omega}_{2I} &= \cos\alpha (\sin\theta \ddot{\phi} + \cos\theta \dot{\phi} + \dot{\theta}) - \frac{r}{R} \Omega (\sec^2\psi \sin\phi \cos\theta \dot{\psi} \\ &\quad + \tan\psi (\cos\phi \cos\theta \dot{\phi} - \sin\phi \sin\theta \dot{\theta}) \\ &\quad + \sin\alpha (\sec^2\psi \cos\phi \sin\theta \dot{\psi} - \tan\psi (\sin\phi \sin\theta \dot{\phi} - \cos\phi \cos\theta \dot{\theta})) \end{aligned} \quad (4.42-b)$$

$$\dot{\omega}_{3 I} = \ddot{\phi} \sin \alpha - \frac{r}{R} \Omega (\sec^2 \psi \cos \phi \dot{\psi} - \tan \psi \sin \phi \dot{\phi}) + \ddot{\theta} \quad (4.42-c)$$

$$\dot{\omega}_{1 II} = \ddot{\phi}$$

$$\omega_{2 II} = -\frac{r}{R} \Omega (\sec^2 \psi \sin \phi \dot{\psi} + \tan \psi \cos \phi \dot{\phi})$$

$$\omega_{3 II} = -\frac{r}{R} \Omega (\sec^2 \psi \cos \phi \dot{\psi} - \tan \psi \sin \phi \dot{\phi})$$

Translational Acceleration Components

Equations (4.41) and (4.40) can be differentiated to yield the translational acceleration of the two systems.

$$\begin{aligned} \dot{v}_{1 I} = & r \Omega \cos \alpha \left(\frac{\sin \psi}{\cos^2 \psi} \dot{\psi} \left(-1 + \frac{a_{II}}{R} \tan \psi \sin \phi \right) \right. \\ & \left. + \frac{a_{II}}{R \cos \psi} (\sec^2 \psi \sin \phi \dot{\psi} + \tan \psi \cos \phi \dot{\phi}) \right) \\ & + h_I (\cos \alpha (\ddot{\phi} \sin \theta + \dot{\phi} \dot{\theta} \cos \theta)) \\ & + \frac{r}{R} \Omega (\sec^2 \psi \sin \phi \cos \theta \dot{\psi} + \tan \psi (\cos \phi \cos \theta \dot{\phi} \\ & - \sin \phi \sin \theta \dot{\theta}) + \sin \alpha (\sec^2 \psi \cos \phi \sin \theta \dot{\psi} \\ & - \tan \psi (\sin \phi \sin \theta \dot{\phi} - \cos \phi \cos \theta \dot{\theta}))) \end{aligned} \quad (4.44-a)$$

$$\begin{aligned} \dot{v}_{2 I} = & -a_I (\ddot{\phi} \sin \alpha - \frac{r}{R} \Omega \cos \alpha (\sec^2 \psi \cos \phi \dot{\psi} \\ & - \tan \psi \sin \phi \dot{\phi}) + \ddot{\theta}) + h_I (\cos \alpha (\cos \theta \ddot{\phi} \\ & - \sin \theta \dot{\phi} \dot{\theta}) - \frac{r}{R} \Omega (\sec^2 \psi \sin \phi \sin \theta \dot{\psi} \\ & + \tan \psi (\cos \phi \sin \theta \dot{\phi} + \tan \psi \sin \phi \cos \theta \dot{\theta}) \\ & - \sin \alpha (\sec^2 \psi \cos \phi \cos \theta \dot{\psi} - \tan \psi (\sin \phi \cos \theta \dot{\phi} \\ & + \cos \phi \sin \theta \dot{\theta}))) \end{aligned} \quad (4.44-b)$$

$$\begin{aligned}
\dot{v}_{3I} = & -r\Omega \sin\alpha \frac{\sin\psi}{\cos^2\psi} \dot{\psi} + a_I (\cos\alpha (\sin\theta \ddot{\phi} + \cos\theta \dot{\phi} \dot{\theta}) \\
& - \frac{r}{R} \Omega (\sec^2\psi \sin\phi \cos\theta \dot{\psi} + \tan\psi (\cos\phi \cos\theta \dot{\phi} \\
& - \sin\phi \sin\theta \dot{\theta})) + \sin\alpha (\sec^2\psi \cos\phi \sin\theta \dot{\psi} \\
& - \tan\psi (\sin\phi \sin\theta \dot{\phi} + \cos\phi \cos\theta \dot{\theta}))
\end{aligned} \tag{4.44-c}$$

$$\dot{v}_{1II} = \frac{r}{R} \Omega a_{II} (\sec^2\psi \sin\phi \dot{\psi} + \tan\psi \cos\phi \dot{\phi}) \tag{4.45-a}$$

$$\dot{v}_{2II} = h_{II} \ddot{\phi} - a_{II} \frac{r}{R} \Omega (\sec^2\psi \cos\phi \dot{\psi} - \tan\psi \sin\phi \dot{\phi}) \tag{4.45-b}$$

$$\dot{v}_{3II} = a_{II} \frac{r}{R} \Omega (\sec^2\psi \sin\phi \dot{\psi} + \tan\psi \cos\phi \dot{\phi}) \tag{4.45-c}$$

Resultant Components of External Forces and Moments

Referring to Fig. (4.1) and considering the tire forces defined in Chapter 3, the following force components act on the front system.

$$\begin{aligned}
F_{1I} = & T_{1CI} - T_{1PI} - C_I r^2 \Omega^2 \cos\alpha - m_I g \cos\beta \sin\alpha \\
& + z(\kappa_1 \sigma \theta) \cos\alpha \sin\beta \sin\alpha + (\kappa_4 \beta) \sin\beta \sin\alpha
\end{aligned} \tag{4.46-a}$$

$$F_{2I} = -T_{2CI} + m_I g \sin\beta + z(\kappa_1 \sigma \theta) \cos\beta \cos\alpha + (\kappa_4 \beta) \cos\beta \tag{4.46-b}$$

$$\begin{aligned}
F_{3I} = & T_{3CI} - T_{3PI} - C_I r^2 \Omega^2 \sin\alpha + m_I g \cos\beta \cos\alpha \\
& - z(\kappa_1 \sigma \theta) \cos^2\alpha \sin\beta - (\kappa_4 \beta) \sin\beta \cos\alpha
\end{aligned} \tag{4.46-c}$$

The following force components act on the rear system.

$$F_{1II} = -T_{1CII} - T_{1PII} - C_{II} r^2 \Omega^2 \tag{4.47-a}$$

$$F_{2II} = T_{2CII} + m_{II} g \sin\phi - (1-z) (\kappa_1 \sigma \theta) \cos\alpha \cos\phi + (\kappa_4 \phi) \cos\phi \tag{4.47-b}$$

$$F_{3II} = -F_{3CII} - F_{3PII} + m_{II}g \cos\phi + (1-z)(\kappa_1\sigma\theta) \cos\alpha \sin\phi \\ - (\kappa_4\phi) \sin\phi \quad (4.47-c)$$

There is an equilibrium at the separation point. Therefore,

$$T_{1CII} = T_{3CI} \sin\alpha + T_{1CI} \cos\theta \cos\alpha + T_{2CI} \sin\theta \cos\alpha \quad (4.48-a)$$

$$T_{2CII} = T_{2CI} \cos\theta - T_{1CI} \sin\theta \quad (4.48-b)$$

$$T_{3CII} = -T_{1CI} \cos\theta \sin\alpha - T_{2CI} \sin\theta \sin\alpha + T_{3CI} \cos\alpha \quad (4.48-c)$$

Combining equations (4.47) and (4.48) gives the following three equations.

$$F_{1II} = T_{1PII} - T_{3CI} \sin\alpha - T_{1CI} \cos\theta \sin\alpha - T_{2CI} \sin\theta \cos\alpha \\ - C_{II} r^2 \Omega^2 \quad 4.49-a)$$

$$F_{2II} = T_{2CI} \cos\theta - T_{1CI} \sin\theta + m_{II}g \sin\phi \\ - (1-z)(\kappa_1\sigma\theta) \cos\alpha \cos\phi + (\kappa_4\phi) \cos\phi \quad (4.49-b)$$

$$F_{3II} = -T_{3PII} + T_{1CI} \cos\theta \sin\alpha + T_{2CI} \sin\theta \sin\alpha - T_{3CI} \cos\alpha \\ + m_{II}g \cos\phi + (1-z)(\kappa_1\sigma\theta) \cos\alpha \sin\phi \\ - (\kappa_4\phi) \sin\phi \quad (4.49-c)$$

From Fig. (4.1), the following moment components can be written for the front system.

$$\begin{aligned}
M_{1I} &= M_{1CI} - T_{2CI} d_I + z(\kappa_2 \sigma \theta) \cos \alpha \cos \beta \sin \alpha \\
&\quad - (\kappa_5 \beta) \cos \beta \sin \alpha - z(\kappa_3 \sigma \theta) \cos^2 \alpha - (\kappa_6 \beta) \cos \alpha \\
&\quad - z(\kappa_1 \sigma \theta) h_I \cos \alpha \cos \beta - (\kappa_4 \beta) h_I \cos \beta
\end{aligned} \tag{4.50-a}$$

$$\begin{aligned}
M_{2I} &= T_{3PI} a_I - T_{1PI} h_I - M_{2CI} - T_{1CI} d_I - T_{3CI} \ell_I \\
&\quad - C_I r^2 \Omega^2 (b_I - h_I \cos \alpha) - z(\kappa_2 \sigma \theta) \cos \alpha \sin \beta \\
&\quad + (\kappa_5 \beta) \sin \beta + (z(\kappa_1 \sigma \theta) \cos \alpha + (\kappa_4 \beta)) (\sin \alpha h_I \\
&\quad + \cos \alpha a_I) \sin \beta
\end{aligned} \tag{4.50-b}$$

$$\begin{aligned}
M_{3I} &= M_{3CI} - T_{2CI} \ell_I + z(\kappa_1 \sigma \theta) \cos \alpha \cos \beta a_I \\
&\quad - (\kappa_2 \sigma \theta) \cos^2 \alpha \cos \beta - (\kappa_3 \sigma \theta) \cos \alpha \sin \alpha \\
&\quad + (\kappa_4 \beta) \cos \beta a_I + (\kappa_5 \beta) \cos \beta \cos \alpha - (\kappa_6 \beta) \sin \alpha
\end{aligned} \tag{4.50-c}$$

The following moment components act on the rear system

$$\begin{aligned}
M_{1II} &= T_{2CII} d_{II} - M_{1CII} + (1-z)(\kappa_1 \sigma \theta) h_{II} \cos \alpha \cos \phi \\
&\quad + (1-z)(\kappa_3 \sigma \theta) \cos \alpha (\kappa_4 \phi) h_{II} \cos \phi - (\kappa_6 \phi)
\end{aligned} \tag{4.51-a}$$

$$\begin{aligned}
M_{2II} &= T_{1PII} h_{II} + C_{II} r^2 \Omega^2 (b_{II} - h_{II}) - T_{3PII} a_{II} \\
&\quad + T_{3CII} \ell_{II} + T_{1CII} d_{II} + M_{2CII} + (1-z)((\kappa_1 \sigma \theta) a_{II} \\
&\quad + (\kappa_2 \sigma \theta)) \cos \alpha \sin \phi - (\kappa_4 \phi) \sin \phi a_{II} + (\kappa_5 \phi) \sin \phi
\end{aligned} \tag{4.51-b}$$

$$\begin{aligned}
M_{3II} = & -T_{2PII} a_{II} - M_{3CII} + T_{2CII} \ell_{II} + (1-z) ((\kappa_1 \sigma \theta) a_{II} \\
& + (\kappa_2 \sigma \theta) \cos \alpha) \cos \phi - (\kappa_4 \phi) \cos \phi a_{II} \\
& - (\kappa_5 \phi) \cos \phi
\end{aligned} \tag{4.51-c}$$

There is a moment equilibrium at the separation point.

$$M_{1CII} = M_{3CI} \sin \alpha + M_{1CI} \cos \theta \cos \alpha + M_{2CI} \sin \theta \cos \alpha \tag{4.52-a}$$

$$M_{2CII} = -M_{1CI} \sin \theta + M_{2CI} \cos \theta \tag{4.52-b}$$

$$M_{3CII} = M_{3CI} \cos \alpha - M_{1CI} \cos \theta \sin \alpha + M_{2CI} \sin \theta \sin \alpha \tag{4.52-c}$$

Equations (4.51) together with equations (4.48) and (4.52)

give

$$\begin{aligned}
M_{1II} = & (T_{2CI} \cos \theta - T_{1CI} \sin \theta) d_{II} - M_{3CI} \sin \alpha \\
& - M_{1CI} \cos \theta \cos \alpha - M_{2CII} \sin \theta \cos \alpha \\
& + (1-z) ((\kappa_1 \sigma \theta) \cos \phi h_{II} + (\kappa_3 \sigma \theta)) \cos \alpha \\
& - (\kappa_4 \phi) h_{II} \cos \phi - (\kappa_6 \phi)
\end{aligned} \tag{4.53-a}$$

$$\begin{aligned}
M_{2II} = & T_{1PII} h_{II} + C_{II} r^2 \Omega^2 (b_{II} - h_{II}) - T_{3PII} a_{II} \\
& + (-T_{1CII} \cos \theta \sin \alpha - T_{2CI} \sin \theta \sin \alpha + T_{3CI} \cos \alpha) \ell_{II} \\
& + (T_{3CI} \sin \alpha - T_{1CI} \cos \theta \cos \alpha + T_{2CI} \sin \theta \cos \alpha) d_{II} \\
& + M_{1CI} \sin \theta + M_{2CI} \cos \theta + (1-z) ((\kappa_1 \sigma \theta) a_{II} \\
& + (\kappa_2 \sigma \theta)) \cos \alpha \sin \phi - (\kappa_4 \phi) \sin \phi a_{II} + (\kappa_5 \phi) \sin \phi
\end{aligned} \tag{4.53-b}$$

$$\begin{aligned}
M_{3II} = & - M_{3CI} \cos\alpha - M_{1CI} \cos\theta \sin\alpha - M_{2CI} \sin\theta \sin\alpha \\
& + (T_{2CI} \cos\theta - T_{1CI} \sin\theta) l_{II} + (1-z) ((\kappa_1 \sigma\theta) a_{II} \\
& + (\kappa_2 \sigma\theta) \cos\alpha \cos\phi - (\kappa_4 \phi) \cos\phi a_{II} + (\kappa_5 \phi) \cos\phi \quad (4.53-c)
\end{aligned}$$

CHAPTER 5

LINEARIZED EQUATIONS OF MOTION

Linearized Velocity and Acceleration Components

Since the stability study is concerned with the motion of the motorcycle running at constant road speed in very nearly upright position and straight ahead trim, the angles θ and ϕ are of very small magnitude. The terms involving the sum of first order and higher order quantities of small magnitude can be linearized to reduce the formidable size of the equations of motion and render the solutions possible.

The following approximations are valid

$$\theta \ll 1$$

$$\phi \ll 1$$

$$\sin \phi = \phi$$

$$\cos \phi = 1$$

$$\sin \theta = \theta$$

$$\cos \theta = 1$$

$$\tan \psi = \psi = (1-\sigma) \theta \cos \alpha$$

$$\dot{\psi} = (1-\sigma) \dot{\theta} \cos \alpha$$

$$\sin \beta = \beta = \phi + \theta \sin \alpha$$

$$\cos \beta = 1$$

Linearized Angular and Translational Velocities

The linearized angular and translational velocity components are

$$\omega_{1I} = \dot{\phi} \cos \alpha + \frac{r}{R} \Omega \sin \alpha \cos \alpha (1-\sigma) \theta \quad (5.1-a)$$

$$\omega_{2I} = 0 \quad (5.1-b)$$

$$\omega_{3I} = \dot{\phi} \sin \alpha - \frac{r}{R} \Omega \cos^2 \alpha (1-\sigma) \theta + \dot{\theta} \quad (5.1-c)$$

$$\omega_{1II} = \dot{\phi} \quad (5.2-a)$$

$$\omega_{2II} = 0 \quad (5.2-b)$$

$$\omega_{3II} = -\frac{r}{R} \Omega (1-\sigma) \theta \cos \alpha \quad (5.2-c)$$

$$v_{1I} = -r \Omega \cos \alpha \quad (5.3-a)$$

$$v_{2I} = -a_I (\dot{\phi} \sin \alpha - \frac{r}{R} \Omega \cos^2 \alpha (1-\sigma) \theta + \dot{\theta}) \\ + h_I \cos \alpha (\dot{\phi} + \frac{r}{R} \Omega \sin \alpha (1-\sigma) \theta) \quad (5.3-b)$$

$$v_{3I} = -r \Omega \sin \alpha \quad (5.3-c)$$

$$v_{1II} = -r \Omega \quad (5.4-a)$$

$$v_{2II} = h_{II} \dot{\phi} - \frac{a_{II} r}{R} \Omega \cos \alpha (1-\sigma) \theta \quad (5.4-b)$$

$$v_{3II} = 0 \quad (5.4-c)$$

Linearized Angular and Translational Accelerations

The linearized angular and translational acceleration components are

$$\dot{\omega}_{1I} = \ddot{\phi} \cos \alpha + \frac{r}{R} \Omega \sin \alpha \cos \alpha (1-\sigma) \dot{\theta} \quad (5.5-a)$$

$$\dot{\omega}_{2I} = 0 \quad (5.5-b)$$

$$\dot{\omega}_{3I} = \ddot{\phi} \sin \alpha - \frac{r}{R} \Omega \cos^2 \alpha (1-\sigma) \dot{\theta} + \ddot{\theta} \quad (5.5-c)$$

$$\dot{\omega}_{1II} = \ddot{\phi} \quad (5.6-a)$$

$$\dot{\omega}_{2II} = 0 \quad (5.6-b)$$

$$\dot{\omega}_{3II} = -\frac{r}{R}\Omega(1-\sigma)\dot{\theta}\cos\alpha \quad (5.6-c)$$

$$\dot{v}_{1I} = 0 \quad (5.7-a)$$

$$\begin{aligned} \dot{v}_{2I} = & -a_I(\ddot{\phi}\sin\alpha - \frac{r}{R}\Omega\cos\alpha(1-\sigma)\dot{\theta} + \ddot{\theta}) \\ & + h_I(\cos\alpha\ddot{\phi} + \frac{r}{R}\Omega\sin\alpha\cos\alpha(1-\sigma)\dot{\theta}) \end{aligned} \quad (5.7-b)$$

$$\dot{v}_{3I} = 0 \quad (5.7-c)$$

$$\dot{v}_{1II} = 0 \quad (5.8-a)$$

$$\dot{v}_{2II} = h_{II}\ddot{\phi} - \frac{a_{II}r}{R}\Omega(\cos\alpha(1-\sigma)\dot{\theta}) \quad (5.8-b)$$

$$\dot{v}_{3II} = 0 \quad (5.8-c)$$

Additional Approximation

The following additional approximations are also valid.

$$\omega_{iI}\omega_{jI} = 0$$

$$\omega_{jII}\omega_{kII} = 0 \quad i, j, k = 1, 2, 3$$

Linearized Force Components

The above linearized quantities can be substituted in equations (4-28) which are

$$F_i = m(\dot{v}_i + \omega_j v_k - \omega_k v_j)$$

and are valid for both the systems.

$$F_{1I} = m_I(\dot{v}_{1I} + \omega_{2I}v_{1I} - \omega_{1I}v_{3I}) = 0 \quad (5.9-a)$$

$$\begin{aligned} F_{2I} = & m_I(\dot{v}_{2I} + \omega_{3I}v_{1I} - \omega_{1I}v_{3I}) \\ = & m_I((-a_I\sin\alpha + h_I\cos\alpha)\ddot{\phi} - a_I\ddot{\theta} + (\frac{1}{R}(a_I \end{aligned}$$

$$\begin{aligned}
& + h_I \sin\alpha (1-\sigma) r \Omega \cos\alpha \dot{\theta} \\
& + \frac{r^2 \Omega^2}{R} \cos\alpha (1-\sigma) \theta
\end{aligned} \tag{5.9-b}$$

$$F_{3I} = m_I (\dot{v}_{3I} + \omega_{1I} v_{2I} - \omega_{2I} v_{1I}) = 0 \tag{5.9-c}$$

$$F_{1II} = m_{II} (\dot{v}_{1II} + \omega_{2II} v_{3II} - \omega_{3II} v_{2II}) = 0 \tag{5.10-a}$$

$$\begin{aligned}
F_{2II} &= m_{II} (\dot{v}_{2II} + \omega_{3II} v_{1II} - \omega_{1II} v_{3II}) \\
&= m_{II} (h_{II} \ddot{\phi} - a_{II} \frac{r}{R} \Omega \cos\alpha (1-\sigma) \dot{\theta} \\
&\quad + \frac{r^2}{R} \Omega^2 (1-\sigma) \cos\alpha \theta)
\end{aligned} \tag{5.10-b}$$

$$F_{3II} = m_{II} (\dot{v}_{3II} + \omega_{1II} v_{2II} - \omega_{2II} v_{1II}) = 0 \tag{5.10-c}$$

Linearized Moment Components

The following relations for moment components for both the systems can be written similarly.

$$\begin{aligned}
M_{1I} &= (I_{11I} \cos\alpha + I_{13I} \sin\alpha) \ddot{\phi} - I'_I \Omega \sin\alpha \dot{\phi} \\
&\quad + \left(\frac{r}{R} \cos\alpha (1-\sigma) (I_{11I} \sin\alpha - I_{13I} \cos\alpha) - I'_I \right) \Omega \dot{\theta} \\
&\quad + I'_I \frac{r}{R} \Omega^2 \cos^2\alpha (1-\sigma) \theta
\end{aligned} \tag{5.11-a}$$

$$M_{2I} = 0 \tag{5.11-b}$$

$$\begin{aligned}
M_{3I} &= (I_{33I} \sin\alpha + I_{13I} \cos\alpha) \ddot{\phi} + I_{33I} \ddot{\theta} + C_f \dot{\theta} \\
&\quad + I'_I \Omega \cos\alpha \dot{\phi} - \frac{r}{R} \Omega \cos\alpha (1-\sigma) (I_{33I} \cos\alpha \\
&\quad - I_{13I} \sin\alpha) \dot{\theta} + I'_I \frac{r}{R} \Omega^2 \sin\alpha \cos\alpha (1-\sigma) \theta
\end{aligned} \tag{5.11-c}$$

$$\begin{aligned}
M_{1II} &= I_{11II} \ddot{\phi} - I_{13II} \frac{r}{R} \Omega (1-\sigma) \cos\alpha \dot{\theta} + C_f \dot{\theta} \sin\alpha \\
&\quad + I'_II \frac{r}{R} \Omega^2 (1-\sigma) \cos\alpha \theta
\end{aligned} \tag{5.12-a}$$

$$M_{2II} = 0 \quad (5.12-b)$$

$$M_{3II} = I_{13II} \ddot{\phi} + I'_{II} \Omega \dot{\phi} - I_{33II} \frac{r}{R} \Omega (1-\sigma) \cos \alpha \dot{\theta} + C_f \dot{\theta} \cos \alpha \quad (5.12-c)$$

Equations (5.9) through (5.12) together with equations (4.46), (4.49), (4.50), and (4.53), and with the assumptions made in the beginning of this chapter give the following twelve simultaneous relations involving as many unknowns

$$\begin{aligned} T_{1CI} - T_{1PI} - C_I r^2 \Omega^2 \cos \alpha - m_I g \sin \alpha \\ - z(\kappa_1 \sigma \theta) (\phi + \theta \sin \alpha) \sin \alpha + ((\kappa_4 \phi) + (\kappa_4 \theta) \sin \alpha) (\phi \\ + \theta \sin \alpha) \sin \alpha = 0 \end{aligned} \quad (5.13)$$

$$\begin{aligned} - T_{2CI} + T_{2PI} + m_I g (\phi + \theta \sin \alpha) + z(\kappa_1 \sigma \theta) \cos \alpha \\ + (\kappa_4 \phi) + (\kappa_4 \theta) \sin \alpha = m_I ((h_I \cos \alpha - a_I \sin \alpha) \ddot{\phi} \\ - a_I \ddot{\theta} + \frac{r}{R} \Omega \cos \alpha (1-\sigma) (h_I \sin \alpha + a_I) \dot{\theta} - r \Omega \cos \alpha \dot{\theta} \\ + \frac{r^2}{R^2} \Omega^2 \cos \alpha (1-\sigma) \theta) \end{aligned} \quad (5.14)$$

$$\begin{aligned} T_{3CI} - T_{3PI} - C_I r^2 \Omega^2 \sin \alpha + m_I g \cos \alpha - z(\kappa_1 \sigma \theta) \cos^2 \alpha (\phi \\ + \theta \sin \alpha) - ((\kappa_4 \phi) + (\kappa_4 \theta) \sin \alpha) (\phi + \theta \sin \alpha) \cos \alpha = 0 \end{aligned} \quad (5.15)$$

$$T_{1PII} - T_{3CI} \sin \alpha - T_{1CI} \cos \alpha - T_{2CI} \theta \cos \alpha - C_{II} r^2 \Omega^2 = 0 \quad (5.16)$$

$$\begin{aligned} T_{2CI} - T_{1CI} \theta + m_{II} g \phi - (1-z)(\kappa_1 \sigma \theta) \cos \alpha + (\kappa_4 \phi) \\ = m_{II} (h_{II} \dot{\phi} - a_{II} \frac{r}{R} \Omega \cos \alpha (1-\sigma) \dot{\theta} \\ - \frac{r^2}{R} \Omega^2 (1-\sigma) \cos \alpha \theta) \end{aligned} \quad (5.17)$$

$$\begin{aligned}
& -T_{3PII} + T_{1CI} + T_{2CII} \sin \alpha \theta - T_{3CI} \cos \alpha + m_{II} g \\
& + (1-z) (\kappa_1 \sigma \theta) \cos \alpha \phi - (\kappa_4 \phi) \phi = 0 \quad (5.18)
\end{aligned}$$

$$\begin{aligned}
& -T_{2PI} h_I + M_{1CI} - T_{2CI} d_I + Z(-(\kappa_1 \sigma \theta) h_I \\
& + (\kappa_2 \sigma \theta) \sin \alpha - (\kappa_3 \sigma \theta) \cos \alpha) \cos \alpha - ((\kappa_4 \phi) \\
& + (\kappa_4 \theta) \sin \alpha) h_I - ((\kappa_5 \phi) + (\kappa_5 \theta) \sin \alpha) \sin \alpha \\
& - ((\kappa_6 \phi) + (\kappa_6 \theta) \sin \alpha) \cos \alpha = (I_{11I} \cos \alpha + I_{13I} \sin \alpha) \ddot{\phi} \\
& - I'_I \Omega \sin \alpha \dot{\phi} + \frac{I}{R} \Omega \cos \alpha (1-\sigma) (I_{11I} \sin \alpha - I_{13I} \cos \alpha) \dot{\theta} \\
& - I'_I \Omega \dot{\theta} + I'_I \frac{I}{R} \Omega^2 \cos^2 \alpha (1-\sigma) \theta \quad (5.19)
\end{aligned}$$

$$\begin{aligned}
& T_{3PI} a_I - T_{1PI} h_I - M_{2CI} - T_{1CI} d_I - T_{3CI} \ell_I + C_I r^2 \Omega^2 (b_I \\
& - h_I \cos \alpha) + Z(\phi + \theta \sin \alpha) ((h_I \sin \alpha + a_I \cos \alpha) (\kappa_1 \sigma \theta) \\
& - (\kappa_2 \sigma \theta)) \cos \alpha + ((\kappa_4 \phi) + (\kappa_4 \theta) \sin \alpha) (\phi + \theta \sin \alpha) (h_I \sin \alpha \\
& + a_I \cos \alpha) + ((\kappa_5 \phi) + (\kappa_5 \theta) \sin \alpha) (\phi + \theta \sin \alpha) = 0 \quad (5.20)
\end{aligned}$$

$$\begin{aligned}
& M_{3CI} - T_{2CI} \ell_I + z \cos \alpha ((\kappa_1 \sigma \theta) a_I - (\kappa_2 \sigma \theta) \cos \alpha \\
& - (\kappa_3 \sigma \theta) \sin \alpha) + ((\kappa_4 \phi) + (\kappa_4 \theta) \sin \alpha) a_I + ((\kappa_5 \phi) \\
& + (\kappa_5 \theta) \sin \alpha) \cos \alpha - ((\kappa_6 \phi) + (\kappa_6 \theta) \sin \alpha) \sin \alpha \\
& = (I_{33I} \sin \alpha + I_{13I} \cos \alpha) \ddot{\phi} + I_{33I} \ddot{\theta} + I'_I \Omega \cos \alpha \dot{\phi} \\
& - \frac{I}{R} \Omega \cos \alpha (1-\sigma) (I_{33I} \cos \alpha - I_{13I} \sin \alpha) \dot{\theta} \\
& + I'_I \frac{I}{R} \Omega^2 \sin \alpha \cos \alpha (1-\sigma) \theta + C_f \dot{\theta} \quad (5.21)
\end{aligned}$$

$$\begin{aligned}
& (T_{2CI} - T_{1CI}\theta) d_{II} - M_{3CI} \sin\alpha - M_{1CI} \cos\alpha \\
& - M_{2CI} \cos\alpha \theta + (1-z) ((\kappa_1 \sigma \theta) h_{II} + (\kappa_3 \sigma \theta)) \cos\alpha \\
& - (\kappa_4 \phi) h_{II} - (\kappa_6 \phi) = I_{11II} \ddot{\phi} - I_{13II} \frac{r}{R} \Omega (1-\sigma) \cos\alpha \dot{\theta} \\
& + I'_{II} \Omega^2 \frac{r}{R} (1-\sigma) \cos\alpha \theta + C_f \dot{\theta} \sin\alpha \quad (5.22)
\end{aligned}$$

$$\begin{aligned}
& T_{1PII} h_{II} + C_{II} (b_{II} - h_{II}) r^2 \Omega^2 - T_{3PII} a_{II} + (-T_{1CI} \sin\alpha - T_{2CI} \sin\alpha \theta \\
& - T_{3CI} \cos\alpha) l_{II} + (T_{3CI} \sin\alpha + T_{1CI} \cos\alpha + T_{2CI} \cos\alpha \theta) d_{II} \\
& - M_{1CI} \theta + M_{2CI} + (1-z) ((\kappa_1 \sigma \theta) a_{II} + (\kappa_2 \sigma \theta)) \cos\alpha \phi \\
& + (-(\kappa_4 \phi) a_{II} + (\kappa_5 \phi)) \phi = 0 \quad (5.23)
\end{aligned}$$

$$\begin{aligned}
& -M_{3CI} \cos\alpha + M_{1CI} \sin\alpha - M_{2CI} \sin\alpha \theta + (T_{2CI} - T_{1CI}) l_{II} \\
& + (1-z) \cos\alpha ((\kappa_1 \sigma \theta) a_{II} + (\kappa_2 \sigma \theta)) - (\kappa_4 \phi) a_{II} + (\kappa_5 \phi) \\
& = I_{13II} \ddot{\phi} - I_{33II} \frac{r}{R} \Omega (1-\sigma) \cos\alpha \dot{\theta} + I'_{II} \Omega \dot{\phi} + C_f \dot{\theta} \cos\alpha \quad (5.24)
\end{aligned}$$

CHAPTER 6

SIMULTANEOUS SOLUTION

Basic Variables

The two variables θ and ϕ are necessary and sufficient to completely describe the attitude of a motorcycle in stability study. Hence the twelve equations of Chapter 5 have to be solved simultaneously to eliminate the remaining ten unknowns and give two second order differential equations containing only θ , ϕ , and their first and second order derivatives.

New Variables

Equations (5.13) through (5.24) can be written as

$$T_{1PI} - T_{1CI} = A_1 \quad (6.1)$$

$$- T_{2CI} = A_2 \quad (6.2)$$

$$T_{3CI} - T_{3PI} = A_3 \quad (6.3)$$

$$T_{1PII} - T_{3CI} \sin\alpha - T_{1CI} \cos\alpha - T_{2CI} \cos\alpha\theta = A_4 \quad (6.4)$$

$$T_{2CI} - T_{1CI} \theta = A_5 \quad (6.5)$$

$$- T_{3PII} + T_{1CI} + T_{2CI} \sin\alpha\theta - T_{3CI} \cos\alpha = A_6 \quad (6.6)$$

$$M_{1CI} - F_{2CI} d_I = A_7 \quad (6.7)$$

$$- T_{3PI} a_I + T_{1PI} h_I + M_{2CI} + T_{1CI} d_I + T_{3CI} l_I \quad (6.8)$$

$$M_{Dr} + M_{3CI} - T_{2CI} l_I = A_9 \quad (6.9)$$

$$T_{2CI} d_{II} - T_{1CI} d_{II} \theta - M_{3CI} \sin \alpha - M_{1CI} \cos \alpha - M_{2CI} \cos \alpha \theta \\ = A_{10} \quad (6.10)$$

$$T_{1PII} h_{II} - T_{3PII} a_{II} + (-l_{II} \sin \alpha + d_{II} \cos \alpha) T_{1CI} + (-l_{II} \sin \alpha \\ + d_{II} \cos \alpha) T_{2CI} \theta + (l_{II} \cos \alpha + d_{II} \sin \alpha) T_{3CI} - M_{1CI} \theta + M_{2CI} \\ = A_{11} \quad (6.11)$$

$$-M_{3CI} \cos \alpha + M_{1CI} \sin \alpha - M_{2CI} \sin \alpha \theta + (T_{2CI} - T_{1CI} \theta) l_{II} = A_{12} \quad (6.12)$$

where the new variables A_j are

$$A_1 = -C_I r^2 \Omega^2 \cos \alpha - m_I g \sin \alpha + (\kappa_4 \phi) \phi \sin \alpha \\ + z \cos \alpha \sin \alpha (\kappa_1 \sigma \theta) (\phi + \theta \sin \alpha) \\ + \sin^2 \alpha ((\kappa_4 \theta) (\phi + \theta \sin \alpha) + (\kappa_4 \phi) \theta) \quad (6.13)$$

$$A_2 = -m_I g (\phi + \theta \sin \alpha) - z \cos \alpha (\kappa_1 \sigma \theta) - (\kappa_4 \phi) \\ - (\kappa_4 \theta) \sin \alpha + m_I (h_I \cos \alpha - a_I \sin \alpha) \ddot{\phi} \\ - m_I a_I \ddot{\theta} + m_I \frac{r}{R} \Omega \cos \alpha (1 - \sigma) (a_I + h_I \sin \alpha) \dot{\theta} \\ - m_I r \Omega \cos \alpha \dot{\theta} + m_I \frac{r^2}{R} \Omega^2 \cos \alpha (1 - \sigma) \theta \quad (6.14)$$

$$A_3 = C_I r^2 \Omega^2 \sin \alpha - m_I g \cos \alpha + z \cos^2 \alpha (\kappa_1 \sigma \theta) (\phi + \theta \sin \alpha) \\ + \cos \alpha \sin \alpha ((\kappa_4 \theta) (\phi + \theta \sin \alpha) + (\kappa_4 \phi) \theta) \quad (6.15)$$

$$A_4 = C_{II} r^2 \Omega^2 \quad (6.16)$$

$$\begin{aligned}
A_5 &= m_{II} h_{II} \ddot{\phi} - m_{II} a_{II} \frac{r}{R} \Omega \cos\alpha (1-\sigma) \dot{\theta} \\
&\quad - m_{II} g \phi - (\kappa_4 \phi) + (1-z) (\kappa_1 \sigma \theta) \\
&\quad - m_{II} \frac{r^2}{R} \Omega^2 (1-\sigma) \cos\alpha \theta
\end{aligned} \tag{6.17}$$

$$A_6 = -m_{II} g - (1-z) (\kappa_1 \sigma \theta) \cos\alpha \phi + (\kappa_4 \phi) \phi \tag{6.18}$$

$$\begin{aligned}
A_7 &= (I_{11I} \cos\alpha + I_{13I} \sin\alpha) \ddot{\phi} - I'_I \Omega \sin\alpha \dot{\phi} \\
&\quad + \frac{r}{R} \Omega \cos\alpha (1-\sigma) (I_{11I} \sin\alpha - I_{13I} \cos\alpha) \dot{\theta} \\
&\quad - I'_I \Omega \dot{\theta} + z \cos\alpha ((\kappa_1 \sigma \theta) h_I - (\kappa_2 \sigma \theta) \sin\alpha \\
&\quad + (\kappa_3 \sigma \theta) \cos\alpha) + \sin\alpha ((\kappa_4 \theta) h_I + (\kappa_5 \theta) \sin\alpha \\
&\quad + (\kappa_6 \theta) \cos\alpha) + I'_I \Omega^2 \frac{r}{R} \cos^2\alpha (1-\sigma) \theta
\end{aligned} \tag{6.19}$$

$$\begin{aligned}
A_8 &= C_I r^2 \Omega^2 (b_I - h_I \cos\alpha) + ((\kappa_5 \phi) + \\
&\quad (\kappa_4 \phi) (h_I \sin\alpha + a_I \cos\alpha)) \phi + (z(-(\kappa_2 \sigma \theta) \cos\alpha \\
&\quad + (\kappa_1 \sigma \theta) \cos\alpha \sin\alpha h_I + (\kappa_1 \sigma \theta) \cos^2\alpha a_I) \\
&\quad + (\kappa_5 \theta) \sin\alpha + (\kappa_4 \theta) \sin\alpha (h_I \sin\alpha + a_I \cos\alpha)) \phi \\
&\quad + ((\kappa_5 \phi) \sin\alpha + (\kappa_4 \phi) \sin\alpha (h_I \sin\alpha + a_I \cos\alpha)) \theta \\
&\quad + (z(-(\kappa_2 \sigma \theta) \cos\alpha \sin\alpha + (\kappa_1 \sigma \theta) (h_I \sin\alpha \\
&\quad + a_I \cos\alpha) \sin\alpha \cos\alpha) + (\kappa_5 \theta) \sin^2\alpha \\
&\quad + (\kappa_4 \theta) \sin^2\alpha (h_I \sin\alpha + a_I \cos\alpha)) \theta
\end{aligned} \tag{6.20}$$

$$\begin{aligned}
A_9 &= (\kappa_4 \phi) a_I - (\kappa_5 \phi) \cos\alpha + (\kappa_6 \phi) \sin\alpha \\
&\quad + z \cos\alpha (-a_I (\kappa_1 \sigma \theta) + (\kappa_2 \sigma \theta) \cos\alpha + (\kappa_3 \sigma \theta) \sin\alpha)
\end{aligned}$$

front and rear tires with the road, as the characteristic length and m_{II} , the mass of the rear system, as the characteristic mass, the nondimensional terms can be defined. To represent the angular velocity Ω , which depicts the road speed, in a nondimensional form, Ω is multiplied by $\sqrt{R/g}$.

Nondimensional Lengths

Front system:

$$a_I^* = \frac{1}{R} a_{II}, \quad d_{II}^* = \frac{1}{R} d_I, \quad \text{etc.}$$

Rear system:

Similar terms represent the nondimensional geometry of the rear system.

$$a_{II}^* = \frac{1}{R} a_{II}, \quad d_{II}^* = \frac{1}{R} d_{II}, \quad \text{etc.}$$

Also, $R^* = 1$.

Nondimensional Mass

$$m_I^* = \frac{1}{m_{II}} m_I$$

$$m_{II}^* = 1$$

Nondimensional Tire Constants

$$\kappa_1^* = \frac{1}{m_{II}g} \kappa_1$$

$$\kappa_2^* = \frac{1}{m_{II}gR} \kappa_2$$

$$\kappa_3^* = \frac{1}{m_{II} g R} \kappa_3$$

$$\kappa_4^* = \frac{1}{m_{II} g} \kappa_4$$

$$\kappa_5^* = \frac{1}{m_{II} g R} \kappa_5$$

$$\kappa_6^* = \frac{1}{m_{II} g R} \kappa_6$$

Nondimensional Road Speed

$$\Omega^* = \Omega \sqrt{R/g} \quad (\text{Froude number})$$

Nondimensional Moments and Products of Inertia

Front system:

$$I_{iiI}^* = \frac{1}{m_{II} R^2} I_{iiI} \quad (i = 1, 2, 3)$$

$$I_{13I}^* = \frac{1}{m_{II} R^2} I_{13I}$$

$$I_I^* = \frac{1}{m_{II} R^2} I_I$$

Rear system:

Similar terms define the nondimensional moments and products of inertia of the rear system.

$$I_{iiII}^* = \frac{1}{m_{II} R^2} I_{iiII}, \text{ etc.}$$

Nondimensional Wind Pressure Constant

$$C_I^* = C_I (R/m_{II})$$

$$C_{II}^* = C_{II} (R/m_{II})$$

Nondimensional Steering Damping

$$C_f^* = (1/m_{II} \sqrt{gR^3}) C_f$$

Nondimensional Driver Input

$$M_{Dr}^* = (1/m_{II} gR) M_{Dr}$$

THE FINAL EQUATIONS OF MOTION

First Equation

Substituting the values of A_j from the equations (6.13) through (6.24) in the equation (7.1), the following equation is obtained.

$$\begin{aligned} & (\kappa_1 \sigma \theta) ((z(\cos 2\alpha(\ell_I - a_I) - \sin 2\alpha(d_I + h_I)) \\ & + (1-z)(-(a_{II} + \ell_{II}) \cos \alpha + (d_{II} + h_{II}) \sin \alpha)) + (\kappa_2 \sigma \theta) ((2z-1) \cos \alpha) \\ & + (\kappa_3 \sigma \theta) (-(2z-1) \sin \alpha) + (\kappa_4 \theta) ((\ell_I + a_I) \cos 2\alpha \tan \alpha \\ & - 2(d_I + h_I) \sin^2 \alpha) + (\kappa_5 \theta) (-\sin \alpha) \\ & + (\kappa_6 \theta) (-\sin \alpha \tan \alpha) + \theta(m_I g(\ell_I \cos 2\alpha \tan \alpha - 2d_I \sin^2 \alpha) \\ & + (1-\sigma) \left(\frac{1}{R} r^2 \Omega^2 (m_I(-\ell_I \cos 2\alpha + d_I \sin 2\alpha) \right. \\ & + m_{II}(-d_{II} \sin \alpha + \ell_{II} \cos \alpha)) + I_I' \Omega^2 \frac{r}{R} (-2 \sin \alpha)) \\ & + (\kappa_4 \phi) \left(\frac{\cos 2\alpha}{\cos \alpha} (a_I + \ell_I) - 2(d_I + h_I) \sin \alpha + a_{II} + \ell_{II} \right. \\ & - (d_{II} + h_{II}) \tan \alpha) + (\kappa_5 \phi) (-2) + (\kappa_6 \phi) (-2 \tan \alpha) \\ & + \phi(m_I g(\ell_I \frac{\cos 2\alpha}{\cos \alpha} - 2d_I \sin \alpha) + m_{II} g(-d_{II} \tan \alpha \\ & + \ell_{II})) + \dot{\theta} \left(\frac{r}{R} \Omega (1-\sigma) (m_I(-a_I \ell_I \cos 2\alpha + a_I d_I \sin 2\alpha \right. \end{aligned} \tag{7.1-a}$$

$$\begin{aligned}
& - l_I h_I \cos 2\alpha \sin \alpha + d_I h_I \sin 2\alpha \sin \alpha) \\
& + m_{II} (a_{II} l_{II} \cos \alpha - a_{II} d_{II} \sin \alpha) + m_I r \Omega (l_I \cos 2\alpha \\
& - d_I \sin 2\alpha) + \frac{r}{R} \Omega (1-\sigma) (-I_{1II} \sin 2\alpha \sin \alpha \\
& - I_{33I} \cos 2\alpha \cos \alpha + I_{13I} \sin 3\alpha - I_{33II} \cos \alpha \\
& + I_{13II} \sin \alpha) + 2I'_I \Omega \sin \alpha + \frac{2 \cos 2\alpha}{\cos \alpha} C_f + \dot{\phi} \Omega (I'_I + I'_{II}) \\
& + \ddot{\phi} (m_I (l_I \cos 2\alpha (a_I \tan \alpha - h_I) + 2d_I \sin \alpha (-a_I \sin \alpha \\
& + h_I \cos \alpha)) + m_{II} h_{II} (d_{II} \tan \alpha - l_{II}) - I_{1II} \sin 2\alpha \\
& + I_{33I} \tan \alpha \cos 2\alpha - I_{13I} (2\sin^2 \alpha - \cos 2\alpha) + I_{13II} \\
& - I_{1III} \tan \alpha) + \ddot{\theta} (m_I a_I (l_I \frac{\cos 2\alpha}{\cos \alpha} - 2d_I \sin \alpha) \\
& + I_{33I} \frac{\cos 2\alpha}{\cos \alpha}) - \frac{\cos 2\alpha}{\cos \alpha} M_{Dr} = 0 \tag{7.1-a}
\end{aligned}$$

Dividing the equation (7.1-a) by $m_{II} gR$ and rearranging the terms in nondimensional groups, the equation can be written as

$$\begin{aligned}
& (\kappa_1^* \sigma \theta) (z (\cos 2\alpha (l_I^* - a_I^*) - \sin 2\alpha (d_I^* + h_I^*))) \\
& + (1-z) (-\cos \alpha (a_{II}^* + l_{II}^*) + \sin \alpha (d_{II}^* + h_{II}^*)) \\
& + (\kappa_2^* \sigma \theta) (\cos \alpha (2z-1)) + (\kappa_3^* \sigma \theta) (\sin \alpha (-2z+1)) \\
& + (\kappa_4^* \theta) ((\cos 2\alpha \tan \alpha (l_I^* + a_I^*) - 2 \sin^2 \alpha (d_I^* + h_I^*))) \\
& + (\kappa_5^* \theta) (-\sin \alpha) + (\kappa_6^* \theta) (-\tan \alpha \sin \alpha) + \theta (m_I^* (l_I \cos 2\alpha \tan \alpha \\
& - 2d_I^* \sin^2 \alpha) + (1-\sigma) (r^* \Omega^*)^2 (m_I^* (-l_I^* \cos 2\alpha + d_I^* \sin 2\alpha)
\end{aligned}$$

$$\begin{aligned}
& + m_{II}^* (-d_{II}^* \sin\alpha + l_{II}^* \cos\alpha) + I_I^* (\Omega^*)^2 r^* (-2 \sin\alpha)) \\
& + (\kappa_4^* \phi) \left(\frac{\cos 2\alpha}{\cos\alpha} (a_I^* + l_I^*) - 2 \sin\alpha (d_I^* + h_I^*) + a_{II}^* \right. \\
& + l_{II}^* - (d_{II}^* + h_{II}^*) \tan\alpha) + (\kappa_5^* \phi) (-2) + (\kappa_6^* \phi) (-2 \tan\alpha) \\
& + \phi (m_I^* (l_I^* \frac{\cos 2\alpha}{\cos\alpha} - 2d_I^* \sin\alpha) + m_{II}^* (-d_{II}^* \tan\alpha + l_{II}^* \theta \\
& + (\dot{\theta} \sqrt{R/g}) (r^* \Omega^* (1-\sigma) (m_I^* (-a_I^* l_I^* \cos 2\alpha + a_I^* d_I^* \sin 2\alpha) \\
& - h_I^* l_I^* \cos 2\alpha \sin\alpha + d_I^* h_I^* \sin 2\alpha \sin\alpha) + m_{II}^* (a_{II}^* l_{II}^* \cos\alpha \\
& - a_{II}^* d_{II}^* \sin\alpha)) + m_I^* r^* \Omega^* (l_I^* \cos 2\alpha - d_I^* \sin 2\alpha) \\
& + r^* \Omega^* (1-\sigma) (-I_{11I}^* \sin 2\alpha \sin\alpha - I_{33I}^* \cos 2\alpha \cos\alpha \\
& + I_{13I}^* \sin 3\alpha - I_{33II}^* \cos\alpha + I_{13II}^* \sin\alpha) + 2I_I^* \Omega^* \sin\alpha + \frac{2 \cos 2\alpha}{\cos\alpha} C_f^*) \\
& + (\dot{\phi} \sqrt{R/g}) (\Omega^* (I_I^* + I_{II}^*)) + \ddot{\phi} (m_I^* (l_I^* \cos 2\alpha (a_I^* \tan\alpha \\
& - h_I^*) + 2d_I^* \sin\alpha (-a_I^* \sin\alpha + h_I^* \cos\alpha)) \\
& + m_{II}^* h_{II}^* (d_{II}^* \tan\alpha - l_{II}^*) - I_{11II}^* \sin 2\alpha + I_{33II}^* \tan\alpha \cos 2\alpha \\
& - I_{13I}^* (2 \sin^2 \alpha - \cos 2\alpha) - I_{11II}^* \tan\alpha + I_{13II}^*) \\
& + (\ddot{\theta} \frac{R}{g}) (m_I^* a_I^* (l_I^* \frac{\cos 2\alpha}{\cos\alpha} - 2d_I^* \sin\alpha) \\
& + I_{33I}^* \frac{\cos 2\alpha}{\cos\alpha}) - \frac{\cos 2\alpha}{\cos\alpha} M_{Dr}^* = 0 \tag{7.1-b}
\end{aligned}$$

Nondimensional Functions

To reduce the size of the equation (7.1-b), the following additional dimensionless terms can be specified as the function of already defined nondimensional motorcycle constants.

$$\begin{aligned}
\lambda_1 &= z(\cos 2\alpha(l_I^* - a_I^*) - \sin 2\alpha(d_I^* + h_I^*) \\
&\quad + (1-z)(-\cos\alpha(a_{II}^* + l_{II}^*) + \sin\alpha(d_{II}^* + h_{II}^*))) \\
\lambda_2 &= \cos 2\alpha \tan\alpha(l_I^* + a_I^*) - 2 \sin^2\alpha(d_I^* + h_I^*) \\
\lambda_3 &= l_I^* \cos 2\alpha \tan\alpha - 2d_I^* \sin^2\alpha \\
\lambda_4 &= (r^*)^2(l_I^* \cos 2\alpha + d_I^* \sin 2\alpha) \\
\lambda_5 &= (r^*)^2(-d_{II}^* \sin\alpha + l_{II}^* \cos\alpha) \\
\lambda_6 &= \frac{\cos 2\alpha}{\cos\alpha}(a_I^* + l_I^*) - 2\sin\alpha(d_I^* + h_I^*) + a_{II}^* + l_{II}^* \\
&\quad - \tan\alpha(d_{II}^* + h_{II}^*) \\
\lambda_7 &= l_I^* \frac{\cos 2\alpha}{\cos\alpha} - 2d_I^* \sin\alpha \\
\lambda_8 &= -d_{II}^* \tan\alpha + l_{II}^* \\
\lambda_9 &= r^*(-a_I^* l_I^* \cos 2\alpha + a_I^* d_I^* \sin 2\alpha - h_I^* l_I^* \cos 2\alpha \sin\alpha \\
&\quad + d_I^* h_I^* \sin 2\alpha \sin\alpha) \\
\lambda_{10} &= r^*(a_{II}^* l_{II}^* \cos\alpha - a_{II}^* d_{II}^* r^* \sin\alpha) \\
\lambda_{11} &= r^*(l_I^* \cos 2\alpha - d_I^* \sin 2\alpha) \\
\lambda_{12} &= a_I^*(l_I^* \frac{\cos 2\alpha}{\cos\alpha} - 2d_I^* \sin\alpha) \\
\lambda_{13} &= l_I^* \cos 2\alpha(a_I^* \tan\alpha - h_I^*) + 2d_I^* \sin\alpha(-a_I^* \sin\alpha + h_I^* \cos\alpha) \\
\lambda_{14} &= h_{II}^*(d_{II}^* \tan\alpha - l_{II}^*)
\end{aligned}$$

$$M_1 = m_I^* \lambda_3$$

$$M_2 = m_I^* \lambda_4$$

$$M_3 = m_I^* \lambda_5$$

$$M_4 = m_I^* \lambda_7$$

$$M_5 = m_{II}^* \lambda_8$$

$$M_6 = m_I^* \lambda_9$$

$$M_7 = m_{II}^* \lambda_{10}$$

$$M_8 = m_I^* \lambda_{11}$$

$$M_9 = m_I^* \lambda_{12}$$

$$M_{10} = m_I^* \lambda_{13}$$

$$M_{11} = m_{II}^* \lambda_{14}$$

$$H_1 = r^* (-I_{11I}^* \sin 2\alpha \sin \alpha - I_{33I}^* \cos 2\alpha \cos \alpha \\ + I_{13I}^* \sin 3\alpha - I_{33II}^* \cos \alpha + I_{13II}^* \sin \alpha)$$

$$H_2 = I_{33I}^* \frac{\cos 2\alpha}{\cos \alpha}$$

$$H_3 = -I_{11I}^* \sin 2\alpha + I_{33I}^* \tan \alpha \cos \alpha - I_{13I}^* (3 \sin^2 \alpha - \cos^2 \alpha) \\ - I_{11II}^* \tan \alpha + I_{13II}^*$$

$$I_1 = I_I^* r^* (-2 \sin \alpha)$$

$$I_2 = 2I_I^* \sin \alpha$$

$$I_3 = (I_I^* + I_{II}^*)$$

Hence equation (7.1-b) in its reduced form can be written as

$$\begin{aligned}
 & (\sigma(\kappa_1^* \lambda_1 + \kappa_2^* \cos\alpha(2z-1) + \kappa_3^*(-2z+1)) + \kappa_4^* \lambda_2 \\
 & - \kappa_5^* \sin\alpha - \kappa_6^* \tan\alpha \sin\alpha + M_1 + (1-\sigma)(M_2(\Omega^*)^2 \\
 & + M_3(\Omega^*)^2 + I_1(\Omega^*)^2))\theta + (\kappa_4^* \lambda_6 - 2\kappa_5^* \\
 & - 2\tan\alpha \kappa_6^* + M_4 + M_5)\phi + (\dot{\theta}(\sqrt{R/g}))((M_6 + M_7)(1-\sigma) \\
 & + M_8 + I_2)\Omega^* + \frac{2\cos 2\alpha}{\cos\alpha} C_f^* + (\dot{\phi}(\sqrt{R/g}))(I_3\Omega^*) \\
 & + (\ddot{\theta}R/g)(M_9 + H_2) + (\ddot{\phi}R/g)(M_{10} + M_{11} + H_3) \frac{\cos 2\alpha}{\cos\alpha} M_{Dr}^* = 0
 \end{aligned} \tag{7.1-c}$$

Physical Character of Nondimensional Functions

λ_j are all functions of nondimensional lengths of the motorcycle geometry ($j = 1, 1, 14$). The dimensionless terms specified above have the following physical interpretations.

- λ_1 : Dependent on slip, related to cornering force.
- λ_2 : Independent of slip, related to camber thrust.
- $\lambda_3 - M_1$: Gravity effect of front system, independent of slip,
- $\lambda_4 - M_2$: Dynamic effect of front system, dependent on slip.
- $\lambda_5 - M_3$: Dynamic effect of rear system, dependent on slip.
- λ_6 : Independent of slip, related to camber thrust.
- $\lambda_7 - M_4$: Gravity effect of front system.
- $\lambda_8 - M_5$: Gravity effect of rear system.
- $\lambda_9 - M_6$: Dynamic effect of front system, dependent on slip.
- $\lambda_{10} - M_7$: Dynamic effect of rear system, dependent on slip.
- $\lambda_{11} - M_8, \lambda_{12} - M_9, \lambda_{13} - M_{11}$: Dynamic effect of front system, independent of slip.
- $\lambda_{14} - M_{11}$: Dynamic effect of rear system, independent of slip.
- H_1 : Inertia effect, dependent on slip.
- H_2, H_3 : Inertia effects, independent of slip.
- I_1 : Gyroscopic effect of front wheel, dependent on slip.
- I_2 : Gyroscopic effect of front wheel, independent of slip.
- I_3 : Gyroscopic effect of both systems, independent of slip.

Second Equation

Before substituting the values of A_j from the equations (6.13) through (6.24) in the equation (7.2), some additional non-dimensional terms are introduced.

$$\begin{aligned}\xi_2 &= (h_{II} \cos \alpha - a_{II} + \xi_1 h_I \cos \alpha - l_I (\xi_1 \sin \alpha + \tan \alpha) \\ &\quad - d_I - l_{II} \sin \alpha + d_{II} \cos \alpha) \\ \xi_3 &= -(h_{II} + d_{II}) \sin \alpha - (a_{II} + l_I \xi_1 + l_{II}) \cos \alpha \\ \xi_4 &= h_{II} \cos \alpha - a_{II} + (h_I + d_I) \xi_1 \cos \alpha - d_{II} (\xi_1 + \frac{1}{\cos \alpha}) \\ &\quad - l_{II} \sin \alpha + d_{II} \cos \alpha \\ \xi_5 &= (\xi_1 + \frac{1}{\cos \alpha})\end{aligned}$$

where ξ_j are all functions of motorcycle geometry.

By substituting the values of A_j in equation (7.2), introducing ξ_j just defined, and rearranging, the following equation is obtained.

$$\begin{aligned}(\kappa_1 \sigma \theta) (z \cos \alpha (\phi + \theta \sin \alpha) (a_I \xi_1 \cos \alpha + \xi_3) \cos \alpha \\ - \frac{1}{\theta} \xi_2 + \frac{1}{\theta} \xi_5 (h_I - a_I \sin \alpha)) + (1-z) \frac{1}{\theta} \cos \alpha (\xi_4 - \xi_5 h_{II}) \\ + (\kappa_2 \sigma \theta) (z \cos \alpha (\frac{1}{\theta} \xi_5 \sin \alpha (-1 + \cos \alpha) \\ + \xi_1 \cos \alpha (\phi + \theta \sin \alpha)) - (1-z) \cos \alpha \phi) \\ + (\kappa \sigma \theta) (\xi_5 \cos \alpha \frac{1}{\theta} (z (\cos \alpha + \sin^2 \alpha) - (1-z)) \\ + (\kappa_4 \phi) (\xi_1 a_I \cos^2 \alpha (\phi + \theta \sin \alpha) - \frac{1}{\theta} \xi_2 + \xi_3 \cos \alpha (\phi + \theta \sin \alpha) \\ - \frac{1}{\theta} \xi_4 + \frac{1}{\theta} \xi_5 (h_I + h_{II} + a_I \sin \alpha)) + (\kappa_4 \theta) (a_I \xi_1 \sin \alpha \cos^2 \alpha (\phi + \theta \sin \alpha)\end{aligned}$$

$$\begin{aligned}
& + h_I \xi_1 (\phi + \theta \sin \alpha) \sin^2 \alpha (\cos \alpha - 1) - \frac{1}{\theta} \xi_2 \sin \alpha \\
& + \xi_3 \sin \alpha \cos \alpha (\phi + \theta \sin \alpha) + \xi_5 h_I \sin \alpha \frac{1}{\theta} \\
& + (\kappa_5 \phi) (\xi_1 \cos \alpha \sin \alpha (\phi + \theta \sin \alpha) + \xi_5 \sin^2 \alpha \frac{1}{\theta} (1 \\
& - \cos \alpha)) + (\kappa_6 \phi) (\frac{1}{\theta} \xi_5 (\cos \alpha + \sin^2 \alpha + 1) \\
& + (\kappa_6 \theta) (\frac{1}{\theta} \xi_5 \sin \alpha (\cos \alpha + \sin^2 \alpha)) + r^2 \Omega^2 (-C_{II} b_{II}) \\
& + r^2 \Omega^2 C_I (h_I \xi_1 \cos^2 \alpha + \xi_3 \sin \alpha) + m_I g (h_I \xi_1 \sin \alpha \cos \alpha \\
& - \xi_2 \sin \alpha - \xi_3 \cos \alpha) - m_I \xi_2 \frac{r^2 \Omega^2}{R} \cos \alpha (1 - \sigma) \\
& + a_{II} m_{II} g - m_{II} \xi_4 r^2 \Omega^2 \frac{1}{R} (1 - \sigma) \cos \alpha \\
& + \xi_5 (1 - \sigma) \frac{r}{R} \Omega^2 \cos \alpha (I'_I (\cos \alpha + \sin^2 \alpha) + I'_{II}) \\
& + \phi (-\xi_2 m_I g \frac{1}{\theta} - \xi_4 m_{II} g \frac{1}{\theta} + \xi_1 \cos \alpha C_I (r^2 \Omega^2) (b_I \\
& - h_I \cos \alpha)) + \dot{\phi} (I'_I \Omega \xi_5 \frac{1}{\theta} \sin \alpha) (-1 + \cos \alpha) \\
& + \dot{\theta} (\xi_2 m_I r \Omega \cos \alpha \frac{1}{\theta} (\frac{1}{R} (1 - \sigma) (a_I + h_I \sin \alpha) - 1) + 2 (\sin \alpha + \tan \alpha) \frac{C_f}{\theta} \\
& - \xi_4 m_{II} a_{II} \frac{1}{R} r \Omega \cos \alpha (1 - \sigma) \frac{1}{\theta} + \xi_5 (\frac{r}{R} \Omega \cos \alpha (1 - \sigma) (I_{1II} \sin \alpha \\
& - I_{13I} \cos \alpha \frac{1}{\theta} + I_{33I} \cos \alpha \sin \alpha \frac{1}{\theta} + I_{13I} \sin^2 \alpha \frac{1}{\theta} \\
& - I_{13II}) - I'_I \Omega \frac{1}{\theta})) + \ddot{\phi} (\xi_2 m_I \frac{1}{\theta} (-a_I \sin \alpha + h_I \cos \alpha) \\
& + \xi_4 m_{II} h_{II} \frac{1}{\theta} + \xi_5 \frac{1}{\theta} (I_{1II} \cos \alpha + I_{13I} \sin \alpha + I_{1III} \\
& + I_{33I} \sin^2 \alpha + I_{13I} \sin \alpha \cos \alpha)) + \ddot{\theta} (-\xi_2 m_I a_I \frac{1}{\theta} \\
& + \xi_5 I_{33I} \sin \alpha \frac{1}{\theta}) - (\xi_1 \sin \alpha + \tan \alpha) \frac{1}{\theta} M_{Dr} = 0
\end{aligned} \tag{7.2-a}$$

Multiplying the equation (7.2-a) by θ and eliminating the higher order terms in summation expressions, the equation is reduced to

$$\begin{aligned}
& (\kappa_1 \sigma \theta) (z (-\xi_2 \cos \alpha + \xi_5 (h_I \cos \alpha - a_I \sin \alpha \cos \alpha)) \\
& - (1-z) (\xi_4 - \xi_5 h_{II}) \cos \alpha) + (\kappa_2 \sigma \theta) (-z \xi_5 \sin \alpha \cos \alpha (1 + \cos \alpha)) \\
& + (\kappa_3 \sigma \theta) (z \xi_5 \cos \alpha (\cos \alpha + \sin^2 \alpha)) \\
& + (\kappa_4 \theta) (-\xi_2 \sin \alpha + \xi_5 h_I \sin \alpha) + (\kappa_5 \theta) (\xi_5 \sin^2 \alpha (1 - \cos \alpha)) \\
& + (\kappa_6 \theta) (\xi_5 \sin \alpha (\cos \alpha + \sin^2 \alpha)) + (\kappa_4 \phi) (-\xi_2 \\
& - \xi_4 + \xi_5 (h_I + a_I \sin \alpha)) + (\kappa_5 \phi) (\xi_5 \sin \alpha) \\
& + (\kappa_6 \phi) (\xi_5 (1 + \cos \alpha + \sin^2 \alpha)) + \theta (r^2 \Omega^2 (-C_{II} b_{II})) \\
& + r^2 \Omega^2 C_I (h_I \xi_1 \cos^2 \alpha + \xi_3 \sin \alpha) + m_I g (h_I \xi_1 \sin \alpha \cos \alpha \\
& - \xi_2 \sin \alpha - \xi_3 \cos \alpha) - m_I \xi_2 \frac{1}{R} r^2 \Omega^2 \cos \alpha (1 - \sigma) \\
& + a_{II} m_{II} g - m_{II} \xi_4 \frac{1}{R} r^2 \Omega^2 (1 - \sigma) \cos \alpha \\
& + \xi_5 (1 - \sigma) \frac{1}{R} r \Omega^2 \cos \alpha (\Gamma'_I (\cos \alpha + \sin^2 \alpha) + \Gamma'_{II}) \\
& + \phi (-\xi_2 m_I g - \xi_4 m_{II} g) + \dot{\phi} (\xi_5 \Gamma'_I \Omega \sin \alpha (1 + \cos \alpha)) \\
& + \dot{\phi} (\xi_5 \Gamma'_I \Omega \sin \alpha (-1 + \cos \alpha)) \\
& + \dot{\theta} (m_I r \Omega \cos \alpha (\frac{1}{R} (1 - \sigma) (a_I + h_I \sin \alpha) - 1) \\
& - \xi_4 m_{II} a_{II} \frac{1}{R} r \Omega \cos \alpha (1 - \sigma) + \xi_5 (\frac{r}{R} \Omega \cos \alpha (1 - \sigma) \\
& (-I_{13} \cos \alpha + I_{33I} \cos \alpha \sin \alpha + I_{13I} \sin^2 \alpha) - \Gamma'_I \Omega)
\end{aligned}$$

$$\begin{aligned}
& + 2(\sin\alpha + \tan\alpha)C_f + \ddot{\phi}(\xi_2 m_I (-a_I \sin\alpha + h_I \cos\alpha) \\
& + \xi_4 m_{II} h_{II} + \xi_5 (I_{11II} \cos\alpha + I_{13I} \sin\alpha + I_{11II} \\
& + I_{33I} \sin^2\alpha + I_{13I} \sin\alpha \cos\alpha)) + \ddot{\theta} (-\xi_2 m_I a_I \\
& + \xi_5 I_{33I} \sin\alpha) - (\xi_1 \sin\alpha + \tan\alpha) M_{Dr} = 0 \quad (7.2-b)
\end{aligned}$$

Dividing the equation (7.2-b) by $(m_{II} gR)$ and rearranging the terms in nondimensional groups, the equation becomes

$$\begin{aligned}
& (\kappa_1^* \sigma \theta) \lambda_{26} + (\kappa_2^* \sigma \theta) \lambda_{27} + (\kappa_3^* \sigma \theta) \lambda_{28} \\
& + (\kappa_4^* \theta) \lambda_{29} + (\kappa_5^* \theta) \lambda_{30} + (\kappa_6^* \theta) \lambda_{31} + C_1 (\Omega^*)^2 \theta \\
& + C_2 (\Omega^*)^2 \theta + \theta (M_{21} + M_{22} + M_{23} (\Omega^*)^2 (1-\sigma) \\
& + M_{24} (\Omega^*)^2 (1-\sigma) + I_{21} (\Omega^*)^2 (1-\sigma)) \\
& + \phi (M_{25} + M_{26} + C_3 (\Omega^*)^2 + \kappa_4^* \lambda_{36} + \kappa_5^* \lambda_{37} \\
& + \kappa_6^* \lambda_{38}) + (\dot{\theta} \sqrt{R/g}) (M_{27} \Omega^* (1-\sigma) + M_{28} \Omega^* (1-\sigma) + M_{29} \Omega^*) \\
& + 2(\sin\alpha + \tan\alpha) C_f^* + H_{21} \Omega^* (1-\sigma) + I_{22} \Omega^*) + (\dot{\phi} \sqrt{R/g}) (I_{23} \Omega^*) \\
& + (\ddot{\theta} (\frac{R}{g})) (M_{30} + H_{22}) + \ddot{\phi} (\frac{R}{g}) (M_{31} + M_{32} + H_{23}) \\
& - (\lambda_{21} \sin\alpha + \tan\alpha) M_{Dr}^* = 0 \quad (7.2-c)
\end{aligned}$$

Nondimensional Functions

The various nondimensional groups introduced in the equation (7.2-c) are as follows.

$$\lambda_{21} = \frac{1}{a_I^* - l_I^*} (\tan\alpha (h_{II}^* + d_{II}^*) + a_{II}^* + l_{II}^*) = \xi_1$$

$$\lambda_{22} = h_{II}^* \cos\alpha - a_{II}^* + \xi_1^* h_I^* \cos\alpha - l_I^* (\xi_1 \sin\alpha + \tan\alpha) - d_I^* - l_{II}^* \sin\alpha + d_{II}^* \cos\alpha = \frac{\xi_2}{R}$$

$$\lambda_{23} = - (h_{II}^* + d_{II}^*) \sin\alpha - (a_{II}^* + l_I^* \xi_1 + l_{II}^*) \cos\alpha = \frac{\xi_3}{R}$$

$$\lambda_{24} = h_{II}^* \cos\alpha - a_{II}^* + (h_I^* + d_I^*) \xi_1 \cos\alpha - d_{II}^* (\xi_1 + \frac{1}{\cos\alpha}) - l_{II}^* \sin\alpha + d_{II}^* \cos\alpha = \frac{\xi_4}{R}$$

$$\lambda_{25} = \xi_1 + \frac{1}{\cos\alpha} = \xi_5$$

$$\lambda_{26} = z(-\lambda_{22} \cos\alpha + \lambda_{25} h_I^* \cos\alpha - \lambda_{25} a_I^* \sin\alpha \cos\alpha) + (1-z)(\lambda_{24} \cos\alpha - \lambda_{25} h_{II}^* \cos\alpha)$$

$$\lambda_{27} = -z \lambda_{25} \sin\alpha \cos\alpha (1 + \cos\alpha)$$

$$\lambda_{28} = \lambda_{25} (z(\cos^2\alpha + \sin^2\alpha \cos\alpha) - (1-z) \cos\alpha)$$

$$\lambda_{29} = \lambda_{22} \sin\alpha + \lambda_{25} h_I^* \sin\alpha + \lambda_{25} \sin^2\alpha d_I^*$$

$$\lambda_{30} = \lambda_{25} \sin^2\alpha (1 - \cos\alpha)$$

$$\lambda_{31} = \lambda_{25} \sin\alpha (\cos\alpha + \sin^2\alpha)$$

$$\lambda_{32} = (\lambda_{21} h_I^* \sin\alpha \cos\alpha - \lambda_{22} \sin\alpha - \lambda_{23} \cos\alpha)$$

$$\lambda_{33} = a_2^*$$

$$\lambda_{34} = -\lambda_{22}(r^*)^2 \cos \alpha$$

$$\lambda_{35} = -\lambda_{24}(r^*)^2 \cos \alpha$$

$$\lambda_{36} = (-\lambda_{22} - \lambda_{24} + \lambda_{25} h_I^* + \lambda_{25} \sin \alpha a_I^* + \lambda_{25} h_2^*)$$

$$\lambda_{37} = \lambda_{25} \sin \alpha$$

$$\lambda_{38} = \lambda_{25}(\cos \alpha + \sin^2 \alpha + 1)$$

$$\lambda_{39} = \lambda_{22} r^* (a_I^* \cos \alpha + h_I^* \sin \alpha \cos \alpha)$$

$$\lambda_{40} = -\lambda_{24} a_2^* r^* \cos \alpha$$

$$\lambda_{41} = -\lambda_{22} r^* \cos \alpha$$

$$\lambda_{42} = -\lambda_{22} a_I^*$$

$$\lambda_{43} = \lambda_{22} (-a_I^* \sin \alpha + h_I^* \cos \alpha)$$

$$\lambda_{44} = \lambda_{24} h_2^*$$

$$M_{21} = m_I^* \lambda_{32}$$

$$M_{22} = m_I^* \lambda_{33}$$

$$M_{23} = m_I^* \lambda_{34}$$

$$M_{24} = m_{II}^* \lambda_{35}$$

$$M_{25} = -m_I^* \lambda_{22}$$

$$M_{26} = -m_{II}^* \lambda_{24}$$

$$M_{27} = m_I^* \lambda_{39}$$

$$M_{28} = m_{II}^* \lambda_{40}$$

$$M_{29} = m_I^* \lambda_{41}$$

$$M_{30} = m_I^* \lambda_{42}$$

$$M_{31} = m_I^* \lambda_{43}$$

$$M_{32} = m_{II}^* \lambda_{44}$$

$$H_{21} = \lambda_{25} r^* (I_{1II}^* \sin \alpha \cos \alpha - I_{13I} \cos^2 \alpha + I_{33I} \cos^2 \alpha \sin \alpha \\ + I_{13I} \sin^2 \alpha \cos \alpha - I_{13II} \cos \alpha)$$

$$H_{22} = \lambda_{25} I_{33I}^* \sin \alpha$$

$$H_{23} = \lambda_{25} (I_{11I}^* \cos \alpha + I_{13I}^* \sin \alpha + I_{11II}^* + I_{33I}^* \sin^2 \alpha \\ + I_{13I}^* \sin \alpha \cos \alpha)$$

$$I_{21} = \lambda_{25} r^* \cos \alpha [I_I^* (\cos \alpha + \sin^2 \alpha) + I_{II}^*]$$

$$I_{22} = -\lambda_{25} I_I^* \sin \alpha (-1 + \cos \alpha)$$

$$C_1 = C_I^* (\lambda_{21} \cos^2 \alpha h_I^* (r^*)^2 + \lambda_{23} r^{*2} \sin \alpha)$$

$$C_2 = -C_{II}^* b_{II}^* (r^*)^2$$

$$C_3 = \lambda_{21} \cos \alpha (b_I^* - h_I^* \cos \alpha) (r^*)^2 C_I^*$$

Physical Character of Nondimensional Functions

λ_j are all functions of dimensionless geometrical lengths of motorcycle ($j = 21, 1, 44$). The physical interpretation of the above nondimensional groups are as follows.

λ_j , ($j = 21, 1, 25$): Convenient groupings of nondimensional geometrical lengths.

λ_{26} : Dependent on slip, related to cornering.
 λ_{27} : Dependent on slip, related to aligning torque.
 λ_{28} : Dependent on slip, related to overturning moment.
 λ_{29} : Independent of slip, related to camber thrust.
 λ_{30} : Independent of slip, related to aligning torque.
 λ_{31} : Independent of slip, related to overturning moment.
 $\lambda_{32} - M_{21}$, $\lambda_{33} - M_{22}$: Gravity effect.
 $\lambda_{34} - M_{23}$, $\lambda_{35} - M_{24}$: Dynamic effect, dependent on slip.
 $\lambda_{22} - M_{25}$, $\lambda_{24} - M_{26}$: Gravity effect.
 λ_{36} : Independent of slip, involves camber thrust.
 λ_{37} : Independent of slip, involves aligning torque.
 λ_{38} : Independent of slip, involves overturning moment.
 $\lambda_{39} - M_{27}$, $\lambda_{40} - M_{28}$: Dynamic effect, dependent on slip.
 $\lambda_{41} - M_{29}$: Dynamic effect, independent of slip.
 $\lambda_{42} - M_{30}$, $\lambda_{43} - M_{31}$, $\lambda_{44} - M_{32}$: Dynamic effect, independent of slip.

H_{21} : Inertia effect, dependent on slip
 H_{22} , H_{23} : Inertia effect, independent of slip.

I_{21} : Gyro effect, dependent on slip
 I_{22} , I_{23} : Gyro effect, independent of slip
 C_1 , C_2 , C_3 : Wind resistance effect.

CHAPTER 8

SOLUTION OF THE EQUATIONS OF MOTION AND COMPUTER CODE

Rewriting the equations (7.1-c) and (7.2-c) respectively in further simplified form and recognizing that Ω^* for each solution is parametric constant.

$$y_1\theta + y_2\dot{\theta} + y_3\ddot{\theta} + y_4\phi + y_5\dot{\phi} + y_6\ddot{\phi} = \frac{\cos 2\alpha}{\cos \alpha} M_{Dr}^* \quad (8.1)$$

$$y_7\theta + y_8\dot{\theta} + y_9\ddot{\theta} + y_{10}\phi + y_{11}\dot{\phi} + y_{12}\ddot{\phi} = (\lambda_1 \sin \alpha + \tan \alpha) M_{Dr}^* \quad (8.2)$$

where

$$\begin{aligned} y_1 = & (\kappa_1^* \lambda_1 + \kappa_2^* \cos \alpha (2z-1) - \kappa_3^* (2z-1)) + \kappa_4^* \lambda_2 \\ & - \kappa_5^* \sin \alpha - \kappa_6^* \sin \alpha \tan \alpha + M_1 + (1-\sigma) (M_2 (\Omega^*)^2 \\ & + M_3 (\Omega^*)^2 + I_1 (\Omega^*)^2) \end{aligned} \quad (8.3)$$

$$y_2 = (((M_6 + M_7) (1-\sigma) + M_8 + I_2) \Omega^* + H_1) \sqrt{R/g} \quad (8.4)$$

$$y_3 = (M_9 + H_2) \frac{R}{g} \quad (8.5)$$

$$y_4 = (\kappa_4^* \lambda_6 - 2\kappa_5^* - 2 \tan \alpha \kappa_6^* + M_4 + M_5) \quad (8.6)$$

$$y_5 = (I_3 \Omega^*) \sqrt{R/g} \quad (8.7)$$

$$y_6 = (M_{10} + M_{11} + H_3) \frac{R}{g} \quad (8.8)$$

$$\begin{aligned} y_7 = & \sigma (\kappa_1^* \lambda_{26} + \kappa_2^* \lambda_{27} + \kappa_3^* \lambda_{28}) + \kappa_4^* \lambda_{29} + \kappa_5^* \lambda_{30} \\ & + \kappa_6^* \lambda_{31} + C_1 (\Omega^*)^2 + C_2 (\Omega^*)^2 + M_{21} + M_{22} \\ & + (1-\sigma) (\Omega^*)^2 (M_{23} + M_{24} + I_1) \end{aligned} \quad (8.9)$$

$$y_8 = (((1-\sigma)(M_{27} + M_{28} + H_{21}) + M_{29} + M_{22})\Omega^*)\sqrt{R/g} \quad (8.10)$$

$$y_9 = (M_{30} + H_{22})\frac{R}{g} \quad (8.11)$$

$$y_{10} = M_{25} + M_{26} + C_3(\Omega^*)^2 + \kappa_3^*\lambda_{36} + \kappa_4^*\lambda_{37} + \kappa_6^*\lambda_{38} \quad (8.12)$$

$$y_{11} = (I_{23}\Omega^*)\sqrt{R/g} \quad (8.13)$$

$$y_{12} = (M_{31} + M_{32} + H_{23})\left(\frac{R}{g}\right) \quad (8.14)$$

Equations (8.1) and (8.2) can be written as

$$P_{11}(D)\theta + P_{12}(D)\phi = F_1(\tau) \quad (8.15)$$

$$P_{21}(D)\theta + P_{22}(D)\phi = F_2(\tau) \quad (8.16)$$

where P_{ij} ($i, j = 1, 2$) denote the polynomial operators which act on θ and ϕ and $F_1(\tau)$ and $F_2(\tau)$ are driver's input.

Eliminating ϕ by Cramer's rule,

$$\begin{vmatrix} P_{11}(D) & P_{12}(D) \\ P_{21}(D) & P_{22}(D) \end{vmatrix} \theta = \begin{vmatrix} P_{11}(D) & F_1(\tau) \\ P_{21}(D) & F_2(\tau) \end{vmatrix} \quad (8.17)$$

or

$$\begin{vmatrix} (y_1 + y_2D + y_3D^2) & (y_4 + y_5D + y_6D^2) \\ (y_7 + y_8D + y_9D^2) & (y_{10} + y_{11}D + y_{12}D^2) \end{vmatrix} \theta = \begin{vmatrix} (y_1 + y_2D + y_3D^2) & F_1(\tau) \\ (y_7 + y_8D + y_9D^2) & F_2(\tau) \end{vmatrix} \quad (8.18)$$

To investigate the automatic stability of motorcycle, the driver's corrective input is taken as zero. Disregarding the driver's input term, equation (8.18) reduces to the following homogeneous form.

$$(\mu_0 D^4 + \mu_1 D^3 + \mu_2 D^2 + \mu_3 D + \mu_4) \theta = 0 \quad (8.19)$$

where

$$\mu_0 = y_6 y_9 - y_{12} y_3 \quad (8.20-a)$$

$$\mu_1 = y_5 y_9 + y_6 y_8 - y_{11} y_3 - y_{12} y_2 \quad (8.20-b)$$

$$\mu_2 = y_4 y_9 + y_5 y_8 + y_6 y_7 - y_{10} y_2 - y_{11} y_2 - y_{12} y_1 \quad (8.20-c)$$

$$\mu_3 = y_4 y_8 + y_5 y_7 - y_{10} y_2 - y_{11} y_1 \quad (8.20-d)$$

$$\mu_4 = y_4 y_7 - y_{10} y_1 \quad (8.20-e)$$

The characteristic equation is

$$\mu_0 \gamma^4 + \mu_1 \gamma^3 + \mu_2 \gamma^2 + \mu_3 \gamma + \mu_4 = 0 \quad (8.21)$$

A computer program was developed to calculate the coefficients μ_j ($j = 0, 1, 4$). The output of this program gave the result in the format required for the input data to the program solving the characteristic equation.

COMPUTER PROGRAM CODE

The following computer notations have been used in the program to represent the various quantities.

 $a_I \dots A1$
 $a_{II} \dots A2$
 $d_I \dots D1$
 $d_{II} \dots D2$
 $h_I \dots H1$
 $h_{II} \dots H2$
 $l_I \dots AL1$
 $l_{II} \dots AL2$
 $r \dots AR$
 $R \dots R$
 $I_{11I} \dots AIX1$
 $I_{11II} \dots AIX2$
 $I_{22I} \dots AIY1$
 $I_{22II} \dots AIY2$
 $I_{33I} \dots AIZ1$
 $I_{33II} \dots AIZ2$
 $I_{13I} \dots PXZ1$
 $I_{13II} \dots PXZ2$
 $a_I^* \dots XA1$
 $a_{II}^* \dots XA2$
 $d_I^* \dots XD1$
 $d_{II}^* \dots XD2$
 $h_I^* \dots XH1$
 $h_{II}^* \dots XH2$
 $l_I^* \dots XL1$
 $l_{II}^* \dots XL2$
 $r^* \dots XR$
 $I_{11I}^* \dots XIX1$
 $I_{11II}^* \dots XIX2$
 $I_{22I}^* \dots XIY1$
 $I_{22II}^* \dots XIY2$
 $I_{33I}^* \dots XIZ1$
 $I_{33II}^* \dots XIZ2$
 $I_{13I}^* \dots XPXZ1$
 $I_{13II}^* \dots XPXZ2$

$\Gamma'_I \dots AII1$
 $\Gamma'_{II} \dots AII2$
 $m_I \dots AM1$
 $m_{II} \dots AM2$
 $\kappa_j \dots AKPAJ$

$C_I \dots C1$
 $C_{II} \dots C2$
 $Z \dots Z$
 $\Omega \dots W$

$\Gamma'^*_I \dots XII1$
 $\Gamma'^*_{II} \dots XII2$
 $m^*_I \dots XM1$
 $m^*_{II} \dots XM2$
 $\kappa^*_j \dots XKPAJ$

$j = (1, 1, 6)$

$C^*_I \dots XC1$
 $C^*_{II} \dots XC2$

$\Omega^* \dots XW$

$(\Omega^*)^2 \dots XXW$

$\lambda_j \dots QJ$
 $C_j \dots XXCJ$
 $H_j \dots XHXJ$
 $I_j \dots XXHJ$
 $M_j \dots XXMJ$
 $Y_j \dots YJ$

$j = 1, 2, \dots$

$\alpha \dots ALFA$

$\sigma \dots SGMA$

Form of the solutions

If γ_j ($j = 1, 2, 3, 4$) be the roots of the characteristic equation, the solution will be a linear combination of the form

$$\theta = C_1 e^{\gamma_1 \tau} + C_2 e^{\gamma_2 \tau} + C_3 e^{\gamma_3 \tau} + C_4 e^{\gamma_4 \tau} \quad (8.22)$$

where C_j ($j = 1, 2, 3, 4$) are arbitrary constants of the solution.

Two of the roots have been found to be a complex pair.

So γ_3 and γ_4 are of the form $\alpha \pm i\beta$. A particularly adaptable form of equation (8.22) is

$$\theta = C'_1 e^{\gamma_1 \tau} + C'_2 e^{\gamma_2 \tau} + C'_3 e^{\alpha \tau} \sin(\beta \tau + \Theta)$$

where C'_1 , C'_2 , C'_3 , and Θ are another set of arbitrary constants.

CHAPTER 9

RESULTS OF ANALYTICAL SOLUTION

In the differential equations of disturbed motion, the concept of stability did not require the small perturbation forces to be included in setting up the equations. The driver input may be considered as another set of perturbations of restoring character, tending to annul the perturbations due to disturbing forces, which was why it could be disregarded. Besides, the analytical investigations have been carried out to determine, in addition to the comparison of performance of a motorcycle under different motorcycle situations, the built-in tendency of a two-wheeled vehicle to straighten itself up without the assistance of driver.

The solution of a differential equation cannot be specified unless the initial conditions are known. A motorcycle is subjected not only to the disturbances of initial conditions, but is acted upon by continuous disturbing forces and corrective inputs of the rider. To picture the motion in the presence of continually acting perturbations, a concept of equivalent initial conditions can be developed.

Equivalent Initial Conditions

The equivalent initial condition is a concept based on the generalization of the Lyapunov's criteria of stability with respect to initial conditions, but looking backwards.

If, at and after any arbitrary instant τ_1 , all the perturbation forces are hypothetically eliminated, then from this instant onwards, the motion can be regarded as though due to a unique set of imaginary initial conditions applied at an arbitrary earlier instant τ_0 . In other words, the resultant motion due to unknown perturbations has been replaced by the one due to a set of initial conditions at τ_0 , such that the motion in both the cases are identical at τ_1 . The motion between the interval $(\tau_1 - \tau_0)$ will, of course, be different in the two cases. The imaginary unique conditions are termed as equivalent initial conditions. The concept is helpful in picturing the motion. The magnitude of the equivalent initial condition will depend on the actual motion at τ_1 and the interval $(\tau_1 - \tau_0)$. The interval $(\tau_1 - \tau_0)$ can be of any arbitrary size. For large intervals, obviously, the equivalent initial conditions will be large if the machine is stable, and small if the machine is unstable. If $(\tau_1 - \tau_0)$ is very small, the equivalent initial conditions will also be always small, and of the order of neighboring perturbations. Therefore it is more meaningful to consider $(\tau_1 - \tau_0)$ as small. The instant τ_1 is arbitrary, it can be specified anywhere, and so the stability may be considered at any instant. However, the knowledge of equivalent initial conditions is not necessary to test the stability of motion. Yet, the interpretation of the roots of the char-

acteristic equation (8.21) does require the knowledge of a qualitative picture of aggregate motion.

Interpretation of Characteristic Roots

If the requirement had only been to specify the region of automatic stability, and not to compare two different motorcycle situations or the performance of the same machine at different speeds, the interpretation of the roots of the equation (8.21) would have required neither a support of logic, nor any assumptions based on practical observations. The necessary and sufficient condition for automatic stability (automatic stability is asymptotic stability as described in Chapter 1) is that all the real roots and real part of the complex roots of the characteristic equation be negative.

The input by the driver is quantitatively unknown and even though it is not included in the solution of differential equations, it cannot be disregarded inasmuch as the knowledge of the character of the quantitatively unknown driver input and related concepts based on observations are essential to make a meaningful interpretation of the four analytical roots.

Of the four roots, two are real, and the other two complex, except for few check solutions corresponding to low speeds of 5 and 10 radians per second (RPS)*. The solutions were run for a speed

*One radian per second is equivalent to .682 mph, and corresponding Froude number is .41128, for the motorcycle of the theoretical analysis.

range of 20 RPS to 160 RPS with 20 RPS increments. Over this entire speed range, one of the real roots is always a large negative value. Therefore, the component solution corresponding to this root is completely ignored.

The fact that in all the solutions for low speeds of 5 and 10 RPS, all the four roots are real and two of them positive, has an important physical significance. A rider can start a motorcycle and can pass through these highly unstable roots to the operating speed, proves that the rider has an effective control on the component solution corresponding to the positive real roots. Furthermore, in all the test runs, the motorcycles oscillated about zero steering angle. Since the complete solution is an aggregate of all the component solutions, the motorcycle should have oscillated about a mean line other than zero in the absence of an effective control of the rider on the component solution corresponding to the real root. Besides, this control did not come from steering input, since the driver did not hold the steering bar during the test runs. This control comes mainly from shift of weight of rider, rather than from steering at the normal operating speeds.

The character of the control of a driver, interpreted mathematically, is that a rider who has the necessary skill to operate a two-wheeled vehicle has learned to effectively control the motion component corresponding to the real root, and can give an assisting

steering response to the handle bars to control the motion component corresponding to the complex roots.

The use of the terms "effective control" and "assisting steering response" is with purpose. The solution component corresponding to real root results in θ varying monotonically which does not involve reaction time to perceive it and then react to it. A driver can exercise full control on this type of disturbance. But the solution component corresponding to the complex roots is oscillatory, and if frequency is large, the driver can only assist the steering response.

The assistance to steering for a motorcycle situation, moderately satisfactory stability-wise, was observed in road tests. A motorcycle, with little or no tendency to damp out on its own, stabilized very soon after the rider held the handle bar.

The region of automatic stability is very limited. No machine will run on its own without driver input outside this region. A driver with normal riding skill, on the other hand, can operate a machine with positive roots without falling over. So, the question is, what characterizes a machine to be regarded as unstable one?

The motion component corresponding to the real root is effectively controlled by the rider unless it is a very high positive value. But if the motion is unstable relative to the complex roots, the driver will have to make efforts persistantly to aid the steering. He will

feel that unless he keeps struggling, he will fall over. According to the mathematical definition (also S. A. E. definition of neutral stability), the machine with driver input is stable, since the oscillations do not go beyond a certain limit. But such a machine will be termed unstable and even unsafe from the point of view of a rider. The more the driver has to struggle, the more unstable the machine. In other words, the more the machine has a tendency to build up its oscillation, the more unstable it is, and vice versa.

In emphasizing the response of driver on component motion, it is not at all meant that a human is capable of distinguishing motion components from an aggregate motion, and react to it in correspondingly required distinct components of human input. The conception is purely abstract, and the actual physical meaning to be understood in mathematical terms is that the skill of riding a two-wheeled vehicle is reacting to perturbations, so that the driver input creates at each instant, such equivalent initial conditions, that the arbitrary constant associated with real root is very close to zero and the arbitrary constant associated with complex roots has smallest value possible.

The above discussion lays down the background for the interpretation of the four roots. After disregarding the one large negative root, the stability is considered in the following five regions.

Region 1 is the region of automatic stability in which the one real root under consideration and the real part of the complex roots are both negative. In this region, the real part of the complex root is significant in comparing stability.

In Region 2, the real root is small positive quantity and the real part of complex root is negative. Region 2 may not always yield undisputed comparison, but the real part of the complex root is likely to compare the stability admitting the driver control.

In Region 3, the real root is large positive quantity and the real part of complex root is negative. In this region, the real root is significant in comparing instability.

In Region 4, the real root is negative, but the real part of complex root is positive. Here, the real part of complex root is significant in comparing instability.

In Region 5, the real root and the real part of complex roots are both positive. In disputable circumstances, judgment may be required to make a choice. If the real root is a small positive quantity, the real part of complex root may be of significance for comparison of instability.

Presentation of Data

The complex root is plotted on Gaussian plane with the variable being investigated as parametric constant. The speed is represented

by Froude number and contours of constant Froude number are drawn. The closeness of these contours indicates that the rate of change of damping coefficient with respect to road speed is small, and vice-versa. The real root has been plotted in the form of a grid with horizontal lines of constant motorcycle parameter. On the grid are superimposed the contours of constant Froude number. The damping coefficients and frequencies are both plotted corresponding to their nondimensional value.

$$\text{Nondimensional frequency, } f^* = f\sqrt{R/g}$$

$$\text{Nondimensional damping coefficient, } \alpha^* = \alpha\sqrt{R/g}$$

The plot on the Gaussian plane and on the grid is particularly adaptable to compare the performance of a motorcycle in which a machine parameter is being changed.

There is no distinct boundary between Region 2 and Region 3, so they are separated by broken lines. In the grid, the values of Froude number on y-axis gives the necessary values of those numbers to specify the different regions on the Gaussian plane.

Since the characteristic roots represent both damping and divergence, depending upon whether they are negative or positive, they have often been mentioned as stability coefficients, rather than damping coefficients.

Results of Analytical Solution

In all the motorcycle situations, there is only a little range of automatic stability (Region 1). Also, over the entire speed range and in all the motorcycle situations, Region 5 never appears. Region 3 is likely to be present in a singular case of Fig. (9-15) at very low speeds. The presence of Region 1, 2, and 4 implies that the roots on the Gaussian plane are significant in comparing the stability (or instability).

The following two general characteristics of the performance of a two-wheeled vehicle are conspicuous over the entire range of Froude number, and for all the motorcycle situations.

i. The frequency of oscillation increases as the Froude number increases. This increase is more appreciable in the higher range of Froude number than in the lower range.

ii. There is a decline in stability coefficient on the Gaussian plane as the Froude number increases. This is true except in only one case. The effect of large value of I_1^* , in the high speed range, is to improve stability as the Froude number increases, contrary to the usual behavior in other motorcycle situations.

1. Effect of Slip σ , Fig. (9.1): σ is varied from .03 to .07.

It is not realistic to change σ over a wider range, while κ_j ($j = 1, 2, 3$) are held constant. There is no appreciable change in

stability coefficients from one value of σ to the next successive value. But as σ is increased, there is an indication, both from real root and real part of the complex root, that the motorcycle will become more and more unstable. The frequency decreases slightly for higher values of σ .

2. Rear Tire, Fig. (9.2): The effect of rear wheel tires of varying cornering stiffness is very slight. The frequencies corresponding to the rear tires of higher cornering stiffness, for the entire speed range, are slightly more than those for tires of lower value. The stability is not very noticeably better for tires of higher cornering stiffness, but the improvement is reflected in both the characteristic roots.

3. Front Tire, Fig. (9.3): The effect of changes of κ_j ($j = 1, 6, 1$) of front tire is more appreciable than the effect of same changes on rear tire. The general trend is however, same. Stability improves with higher κ_j values and the reduced frequency f^* increases. The results do not indicate an optimum tire.

4. Both Tires, Fig. (9.4): The trend in the change of motorcycle performance, when both the tires are changed together, is same. The combined effect of the change of both tires does not seem to be an aggregate of the Results 2 and 3. Increasing κ_j values of both the tires appears to have a slightly more profound effect on the

motorcycle performance, particularly at higher Froude number.

The trend in the change in frequency is the same.

5. Rake Angle, Fig. (9.5): An increase in rake angle results in an improvement of stability. The real root, however, tends to increase towards positive side, thus there will be a limit imposed by the real root on the higher values of rake angle. In the Gaussian plane, the machine may be stable even at very large value of rake angle, but the large positive value of the real root will bring the motorcycle in Region 4 or Region 5, depending on the Froude number, resulting in a tendency of the machine to collapse under gravity.

An optimum value of rake angle is possible.

6. Trail, Fig. (9.6): Increasing the trail improves stability as reflected on Gaussian plane, but the real root grid shows an opposite effect. As long as the component motion corresponding to the real roots is under control of the riding skill of a driver, increasing the trail will help the stability. The stability root, even on the Gaussian plane, tends to flatten out, and therefore increasing the trail indefinitely will be of very little value. Besides, a very little advantage gained on complex roots will be offset by the high positive value of real root. This positive value will make the machine unstable in Region 3, and in Region 5, if it did appear. An optimum value of trail is suggested which will be specified on the Gaussian

plane, but should also be acceptable on the real root grid. Decreasing the trail from optimum value results in a decline of stability, as indicated by both the stability coefficients. This decline continues even after the trail has reached zero and crossed it. The frequency increases as the trail decreases, becomes maximum at zero, and decreases for negative values of trail.

7. I_I^* , Fig. (9.7): The effect of increase of the moment of inertia of the front wheel (i. e., the gyroscopic effect) is to improve the stability substantially at higher Froude numbers, without seriously impairing the stability at lower Froude numbers. However I_I^* can not be increased without limit. The real root grid suggests that a very large value of I_I^* is likely to make the real characteristic root a very large positive number, which will make the machine unstable, particularly at low speeds.

8. I_{II}^* , Fig. (9.8): The effect of increase of I_{II}^* (increased gyro effect of rear wheel) at lower Froude number is quite inappreciable, but at higher speeds, a small improvement in the stability is perceived with an increase in I_{II}^* . The frequency decreases slightly for higher values of I_{II}^* .

9. m_I^* , Fig. (9.9): For smaller values of m_I^* , stability is better on the Gaussian plane in the entire range of Froude number. The

real root grid is of the same character. The frequency increases with increase in m_I^* .

10. I_{33I}^* , Fig. (9.10): In the Gaussian plane, a decrease in I_{33I}^* results in an improvement of stability and an increase in f^* over the entire range of Froude number. Smaller value of I_{33I}^* at higher Froude number, results in greater change in f^* . The real root grid shows very minor change in stability root. No optimum value of I_{33I}^* is indicated by the analytical results.

11. a_I^* , Fig. (9.11): The stability roots on the Gaussian plane very definitely indicate an optimum position of the front center of gravity measured along the x_{1I} -axis. The frequency decreases with increase in a_I^* . The real root grid is not critical.

12. h_I^* , Fig. (9.12): The effect of change of the height of the center of gravity of the front system is very slight, showing an improvement for smaller values of h_I^* . The reduced frequencies f^* have, over the entire range of Froude number, larger value for smaller h_I^* , although the change is very nominal. The trend of both the characteristic roots, with change in h_I^* , is the same. There is no optimum value of h_I^* .

13. h_{II}^* , Fig. (9.13): The effect of decreasing h_{II}^* is to improve stability, which is reflected in both the roots. The reduced frequency

increases as the center of gravity of the rear system is lowered.

There is no optimum value of h_{II}^* .

14. a_{II}^* , Fig. (9.14): At low Froude number, the effect of change of a_{II}^* is inappreciable. At higher Froude numbers, however, a small improvement in stability, with a very little increase in f^* , is observed for larger values of a_{II}^* .

15. Steering Damper, Fig. (9.15): At low Froude number, the steering damper affects the stability very adversely. The real root increases more sharply than does the real part of the complex root on Gaussian plane. At low speeds, there is no optimum damping. Between the values 32.9 and 41.128 of Ω^* , a slight damping seems to be better than no damping on the steering at all. But at higher Froude number ($\Omega^* > 41.128$), there is definitely an optimum damping. The slope of stability coefficients in the real root grid indicates that very large damping on the steering will not only tend to make the motorcycle unstable at high speeds, but also make it inoperable at lower speeds.

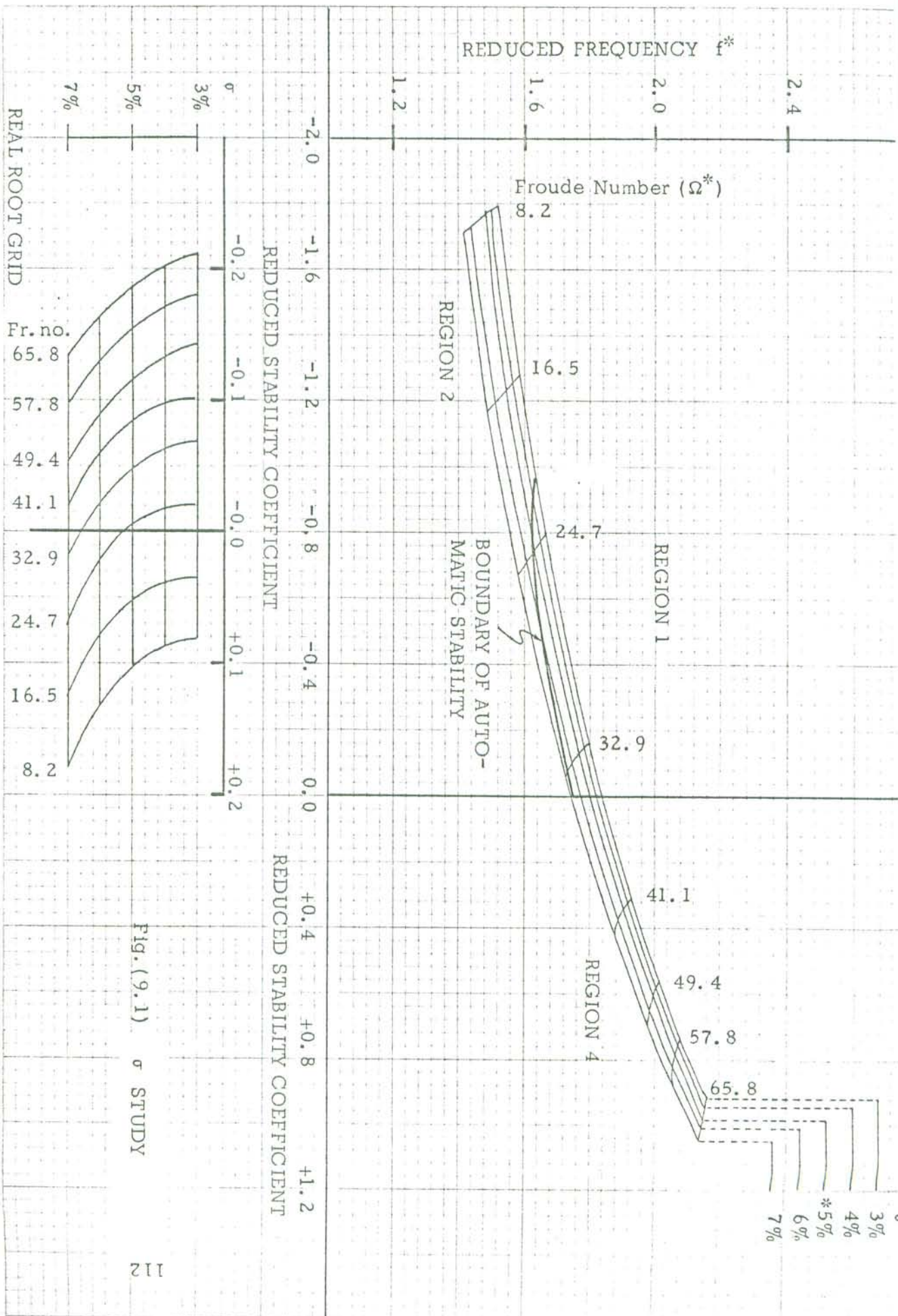

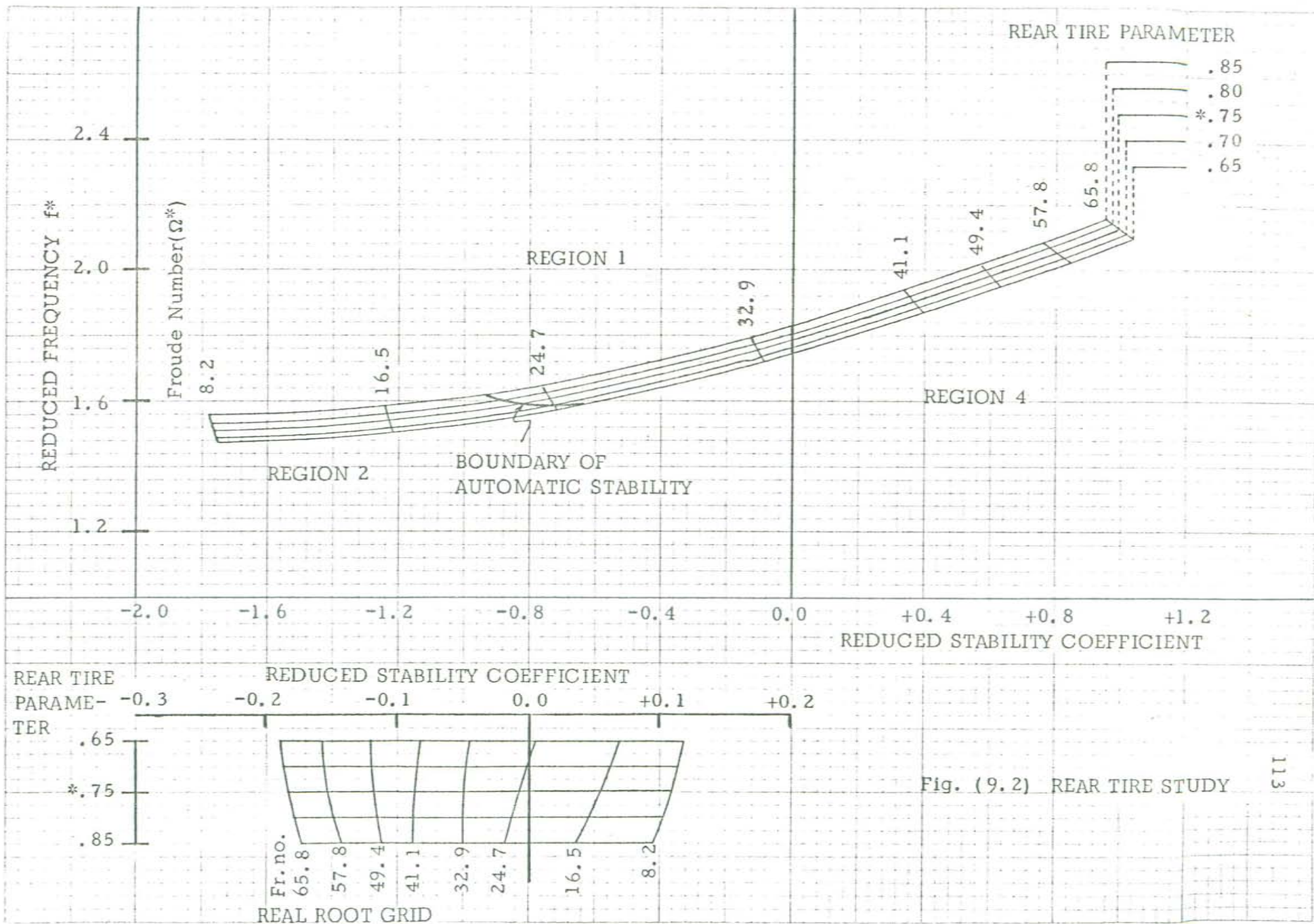

Fig. (9.2) REAR TIRE STUDY

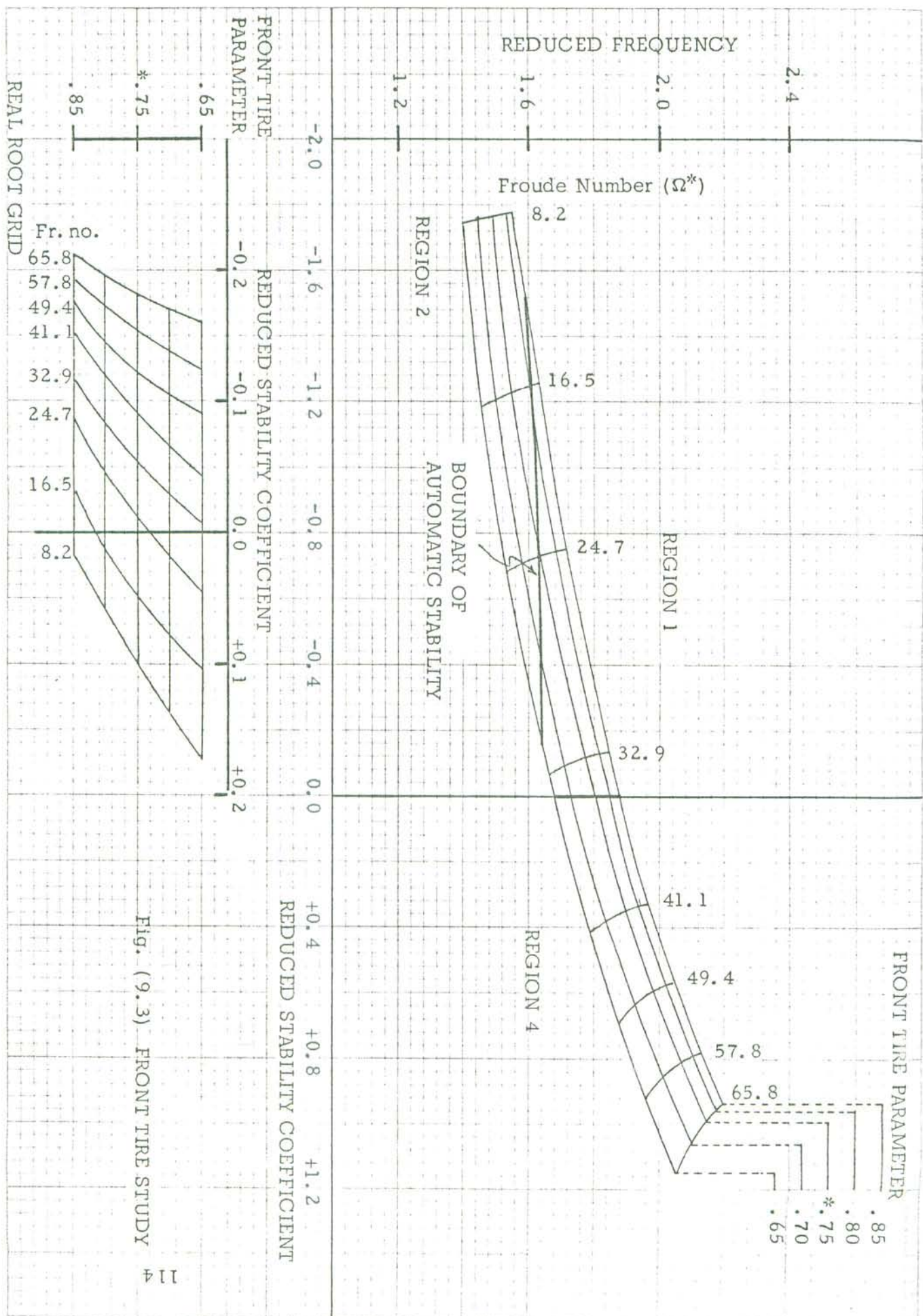

Fig. (9.3) FRONT TIRE STUDY

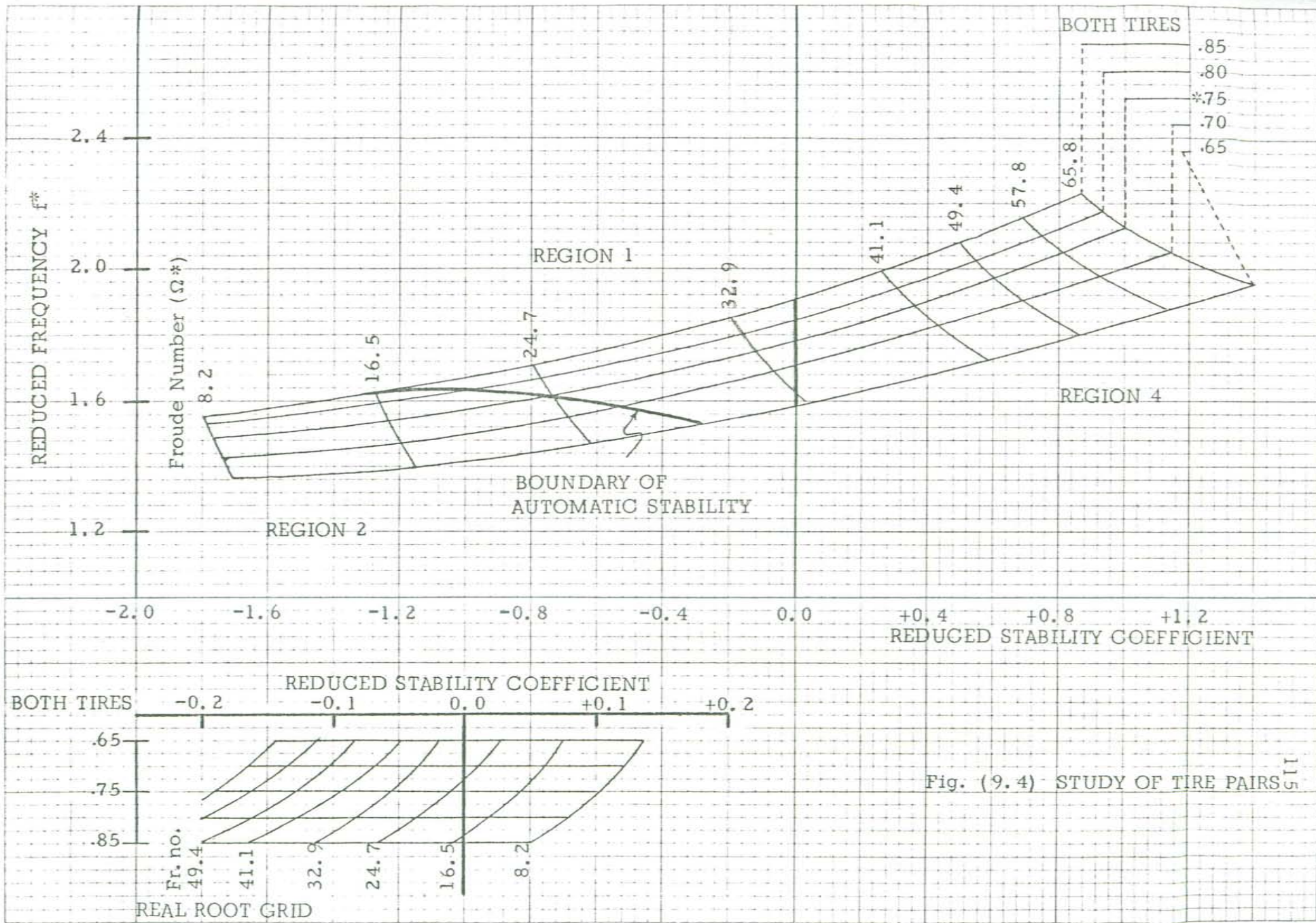

Fig. (9.4) STUDY OF TIRE PAIRS

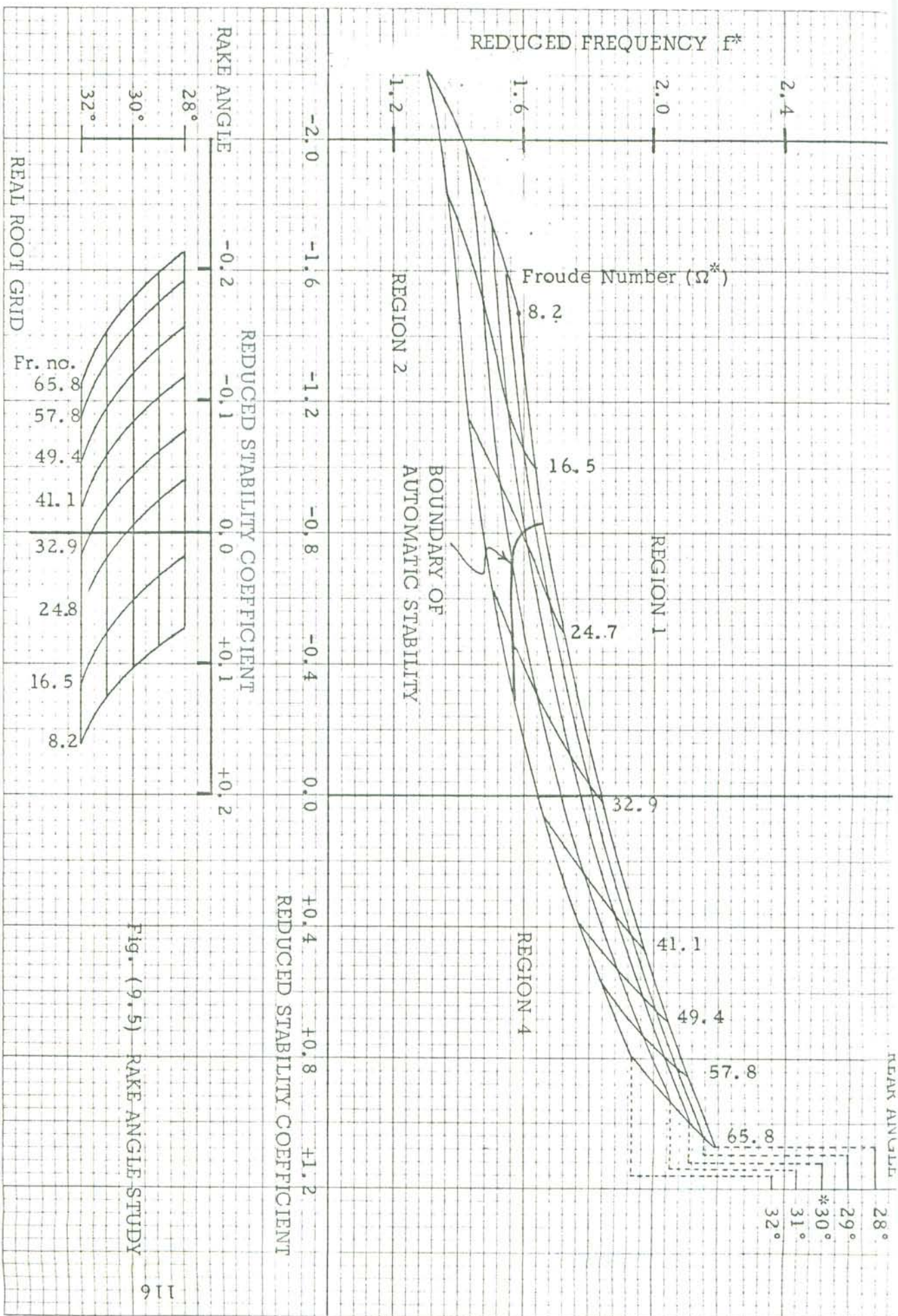
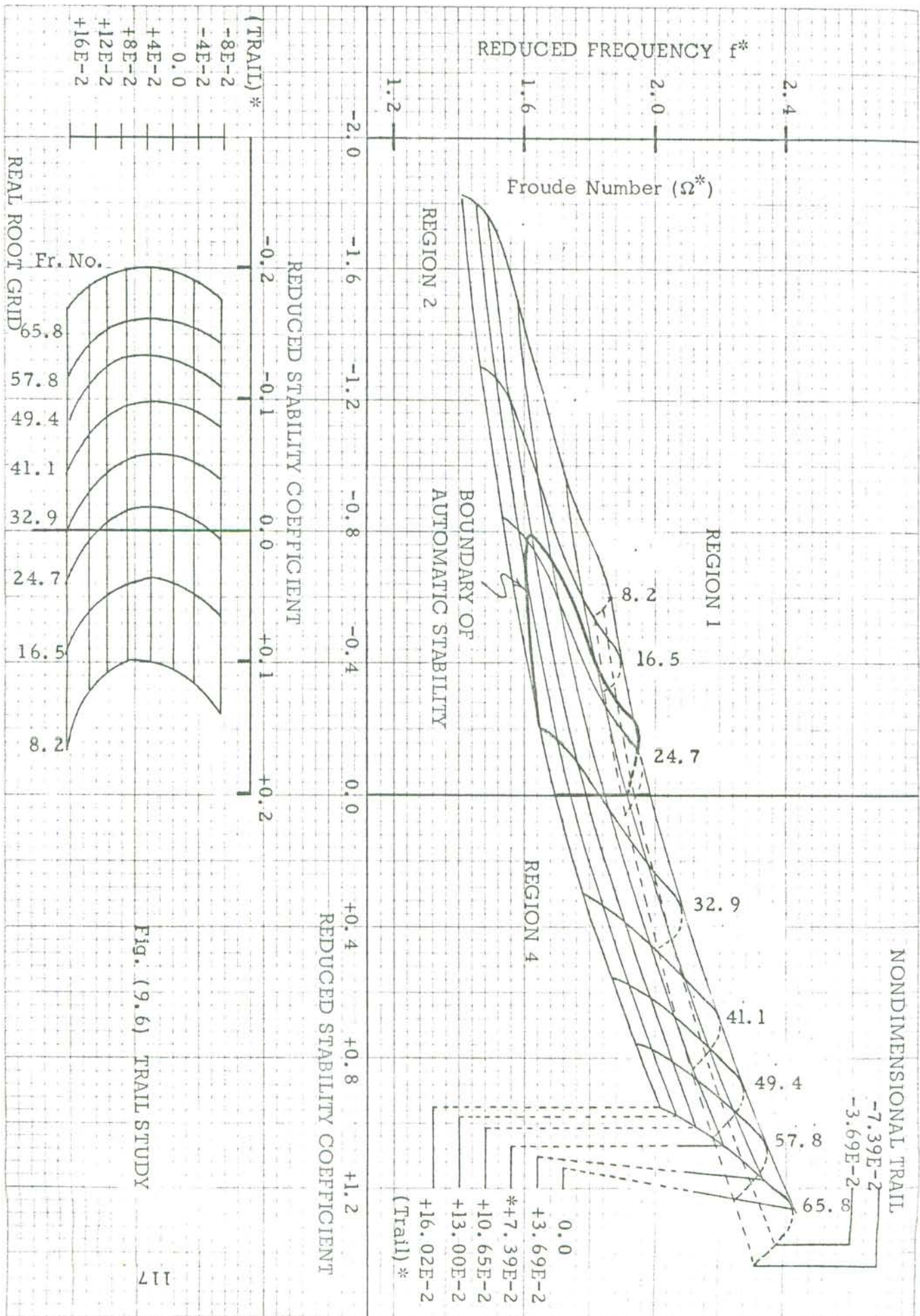

Fig. (9.5) RAKE ANGLE STUDY



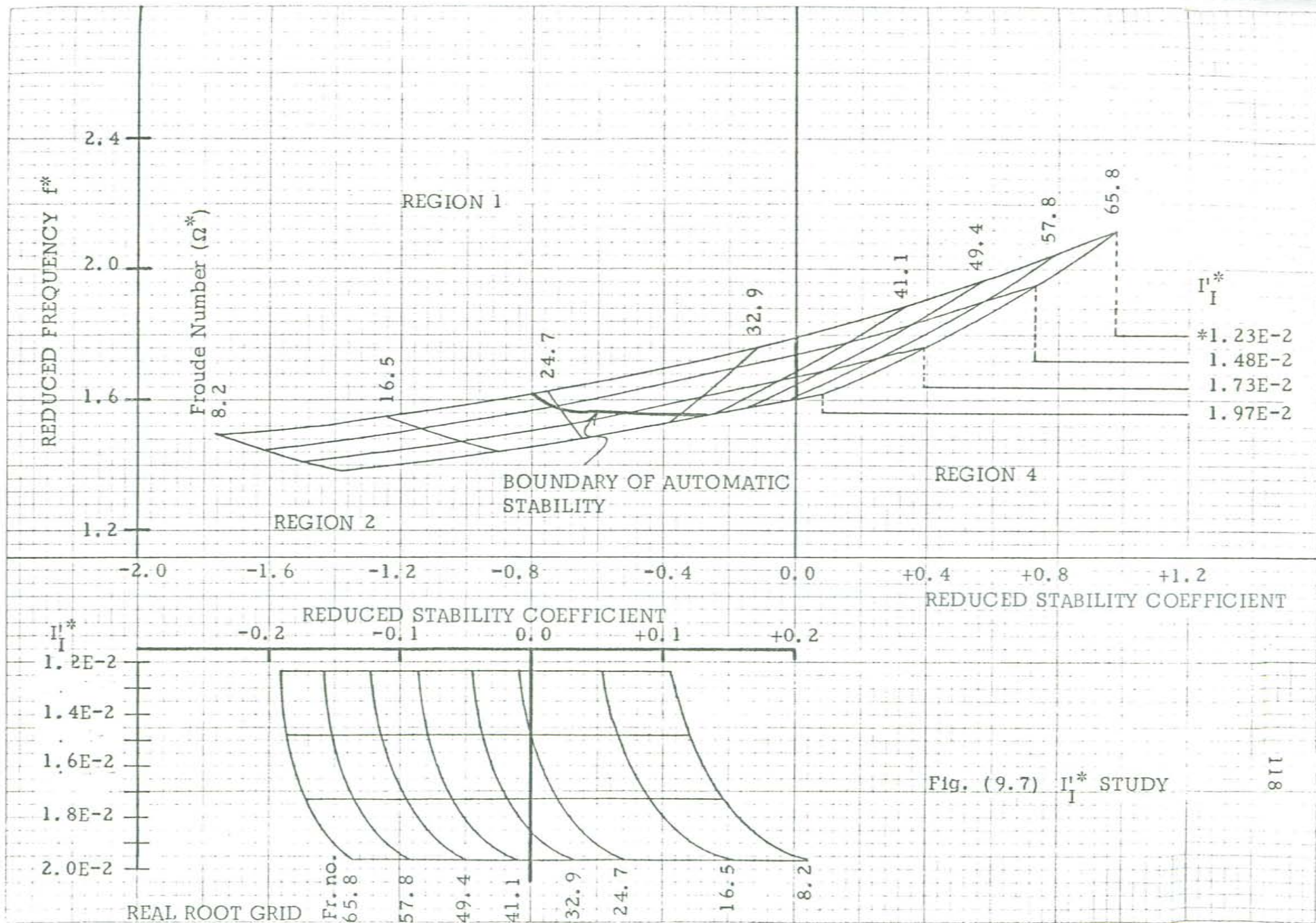

Fig. (9.7) I_1^* STUDY

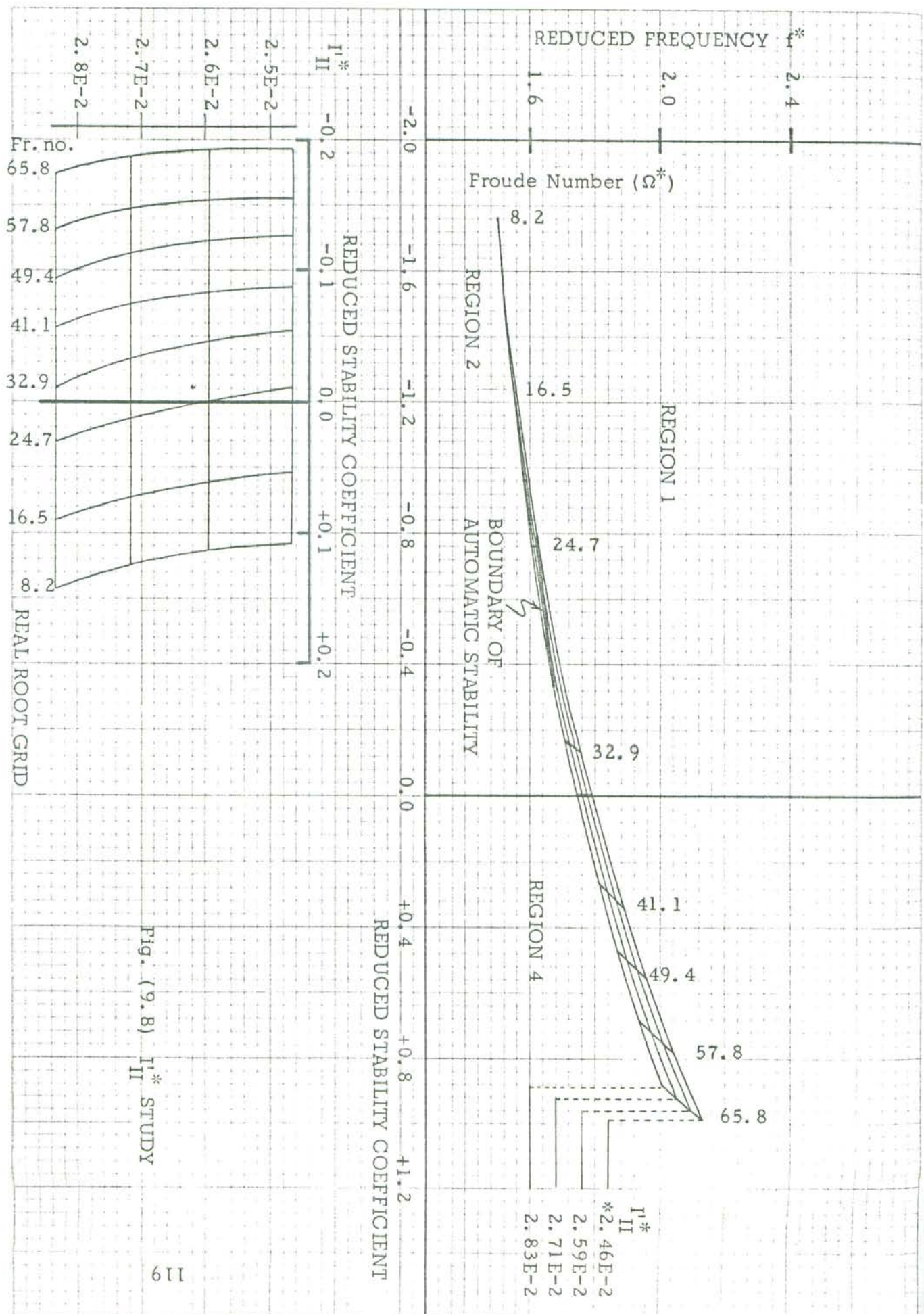

Fig. (9.8) I_{II}^* STUDY

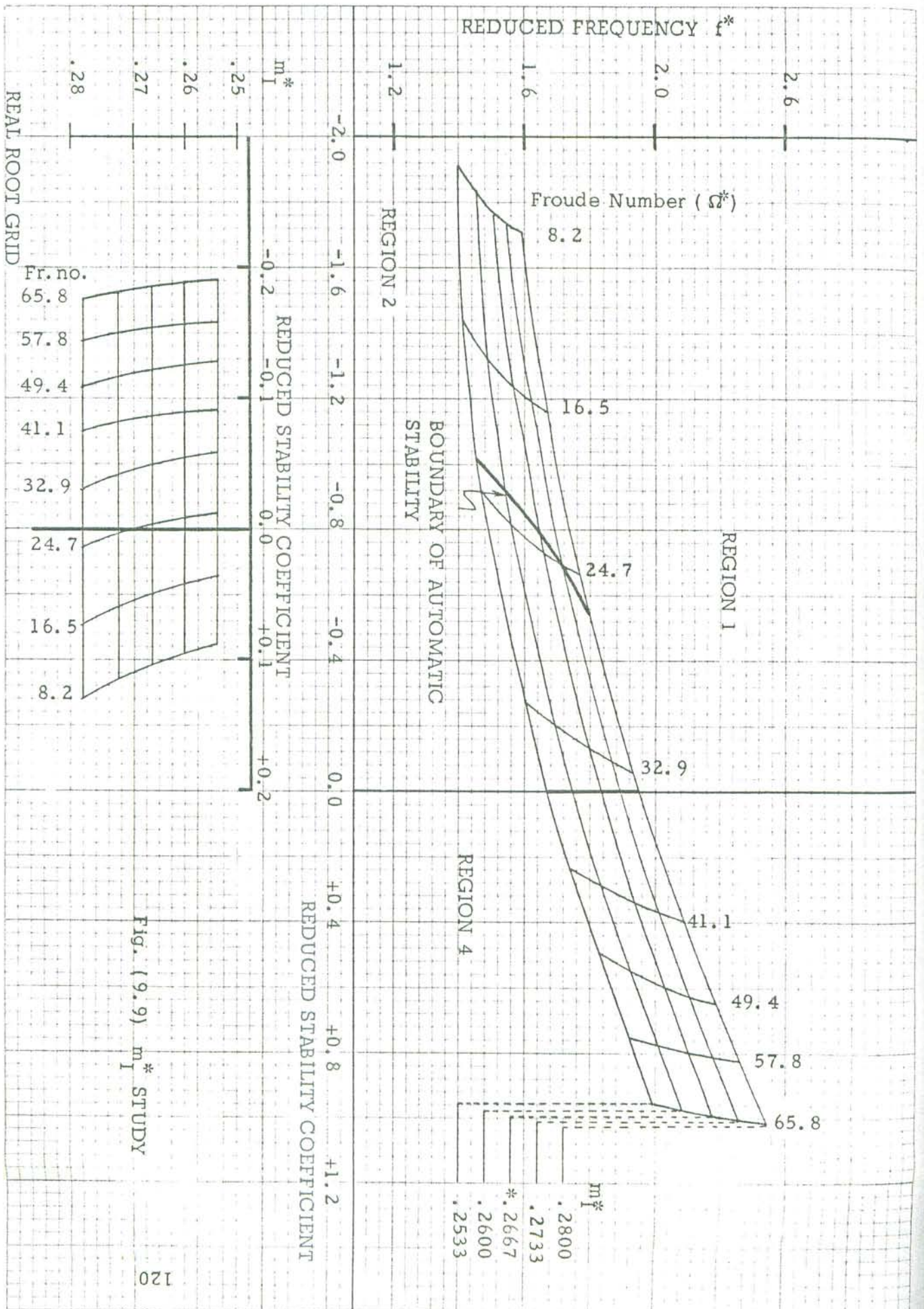
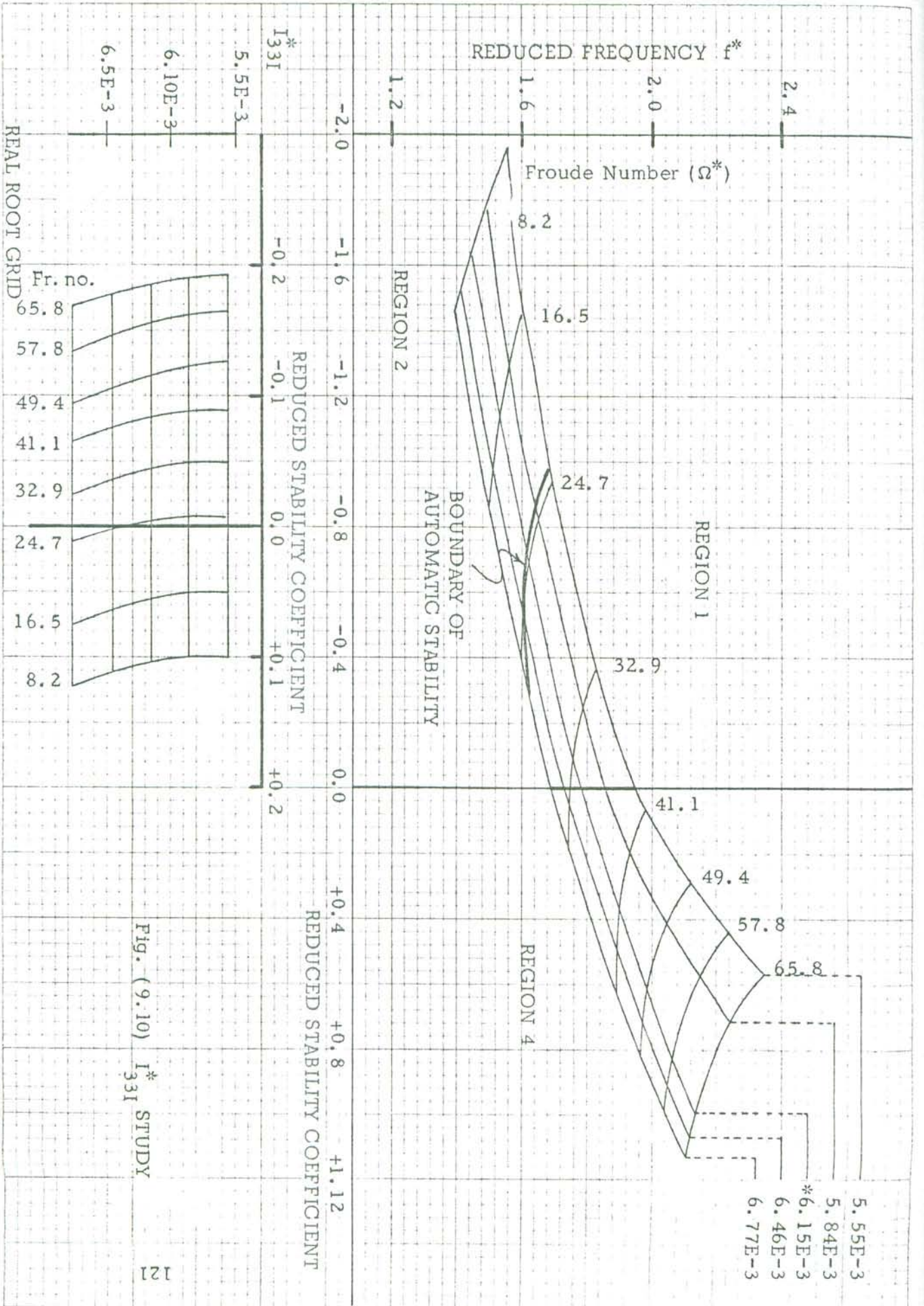

Fig. (9.9) m_1^* STUDY



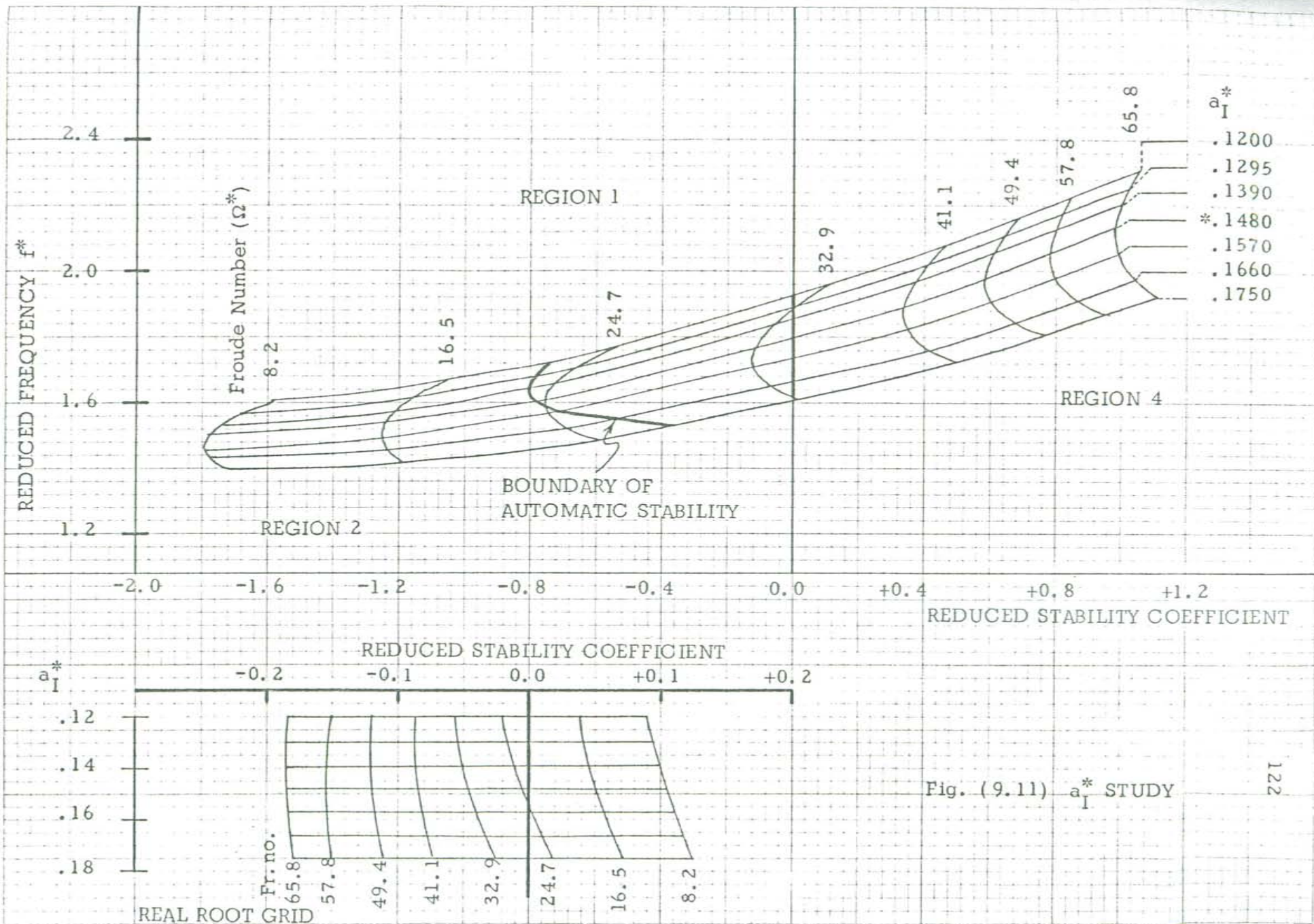

Fig. (9.11) a_I^* STUDY

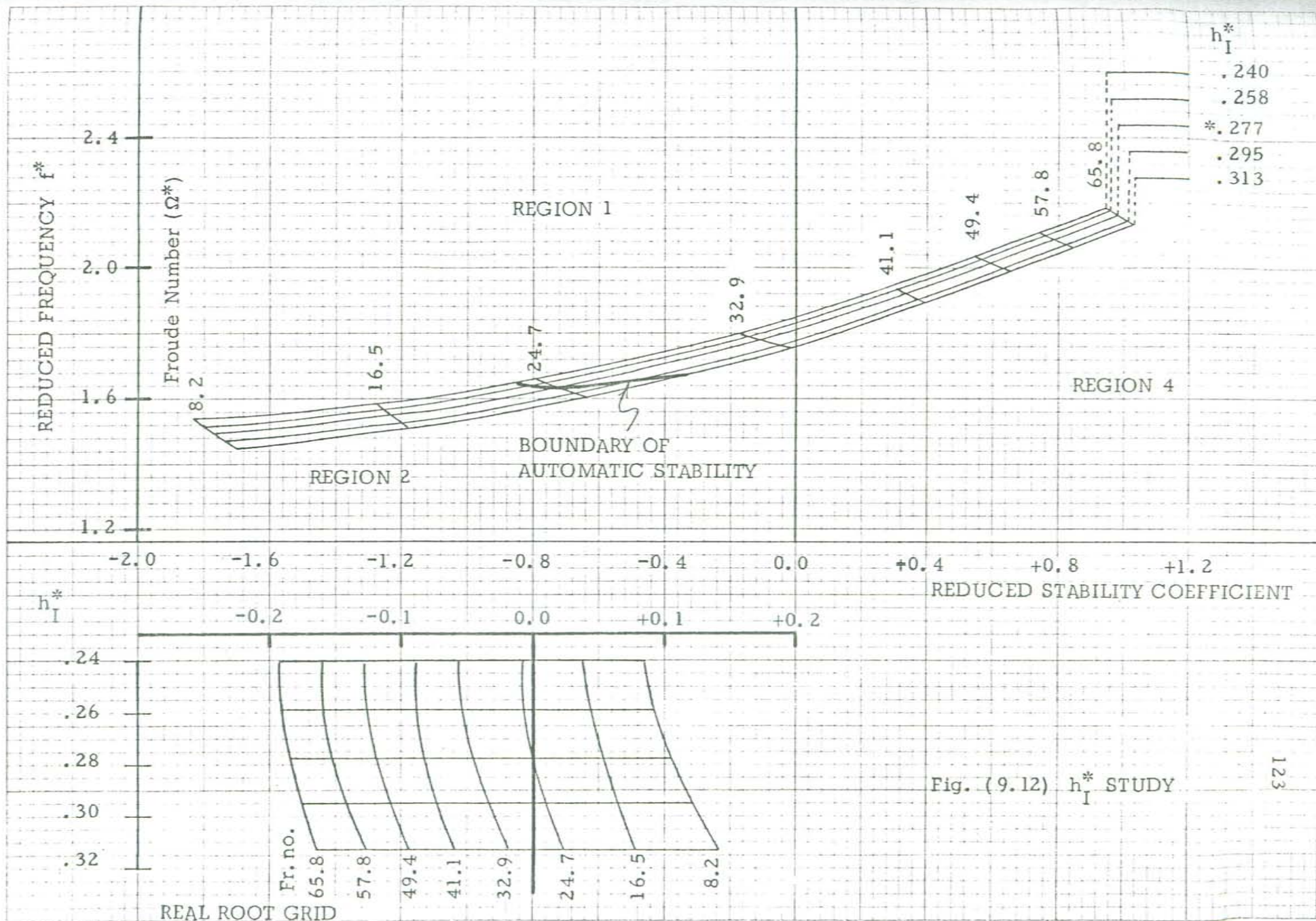

Fig. (9.12) h_I^* STUDY

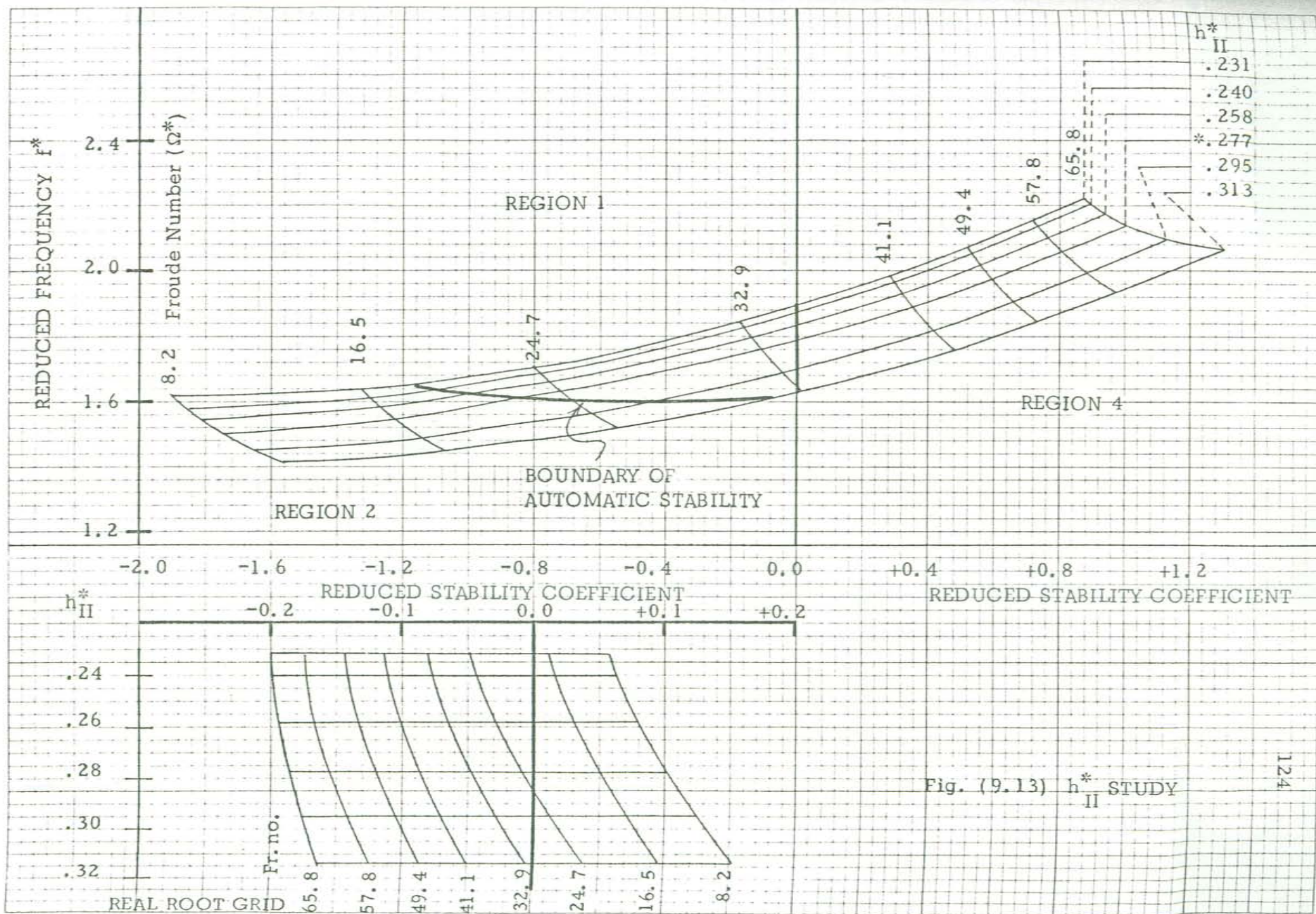

Fig. (9.13) h_{II}^* STUDY

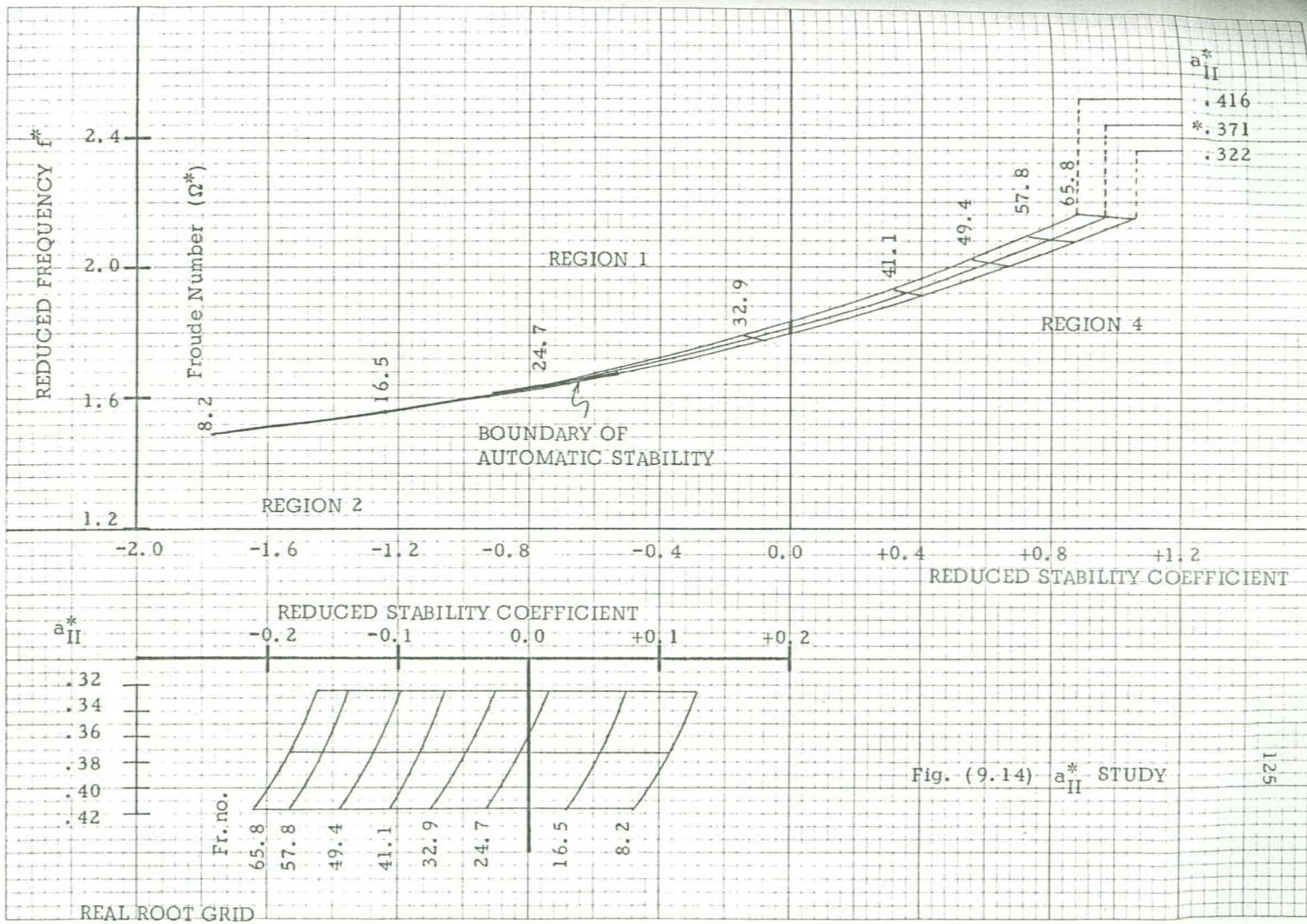

Fig. (9.14) a_{II}^* STUDY

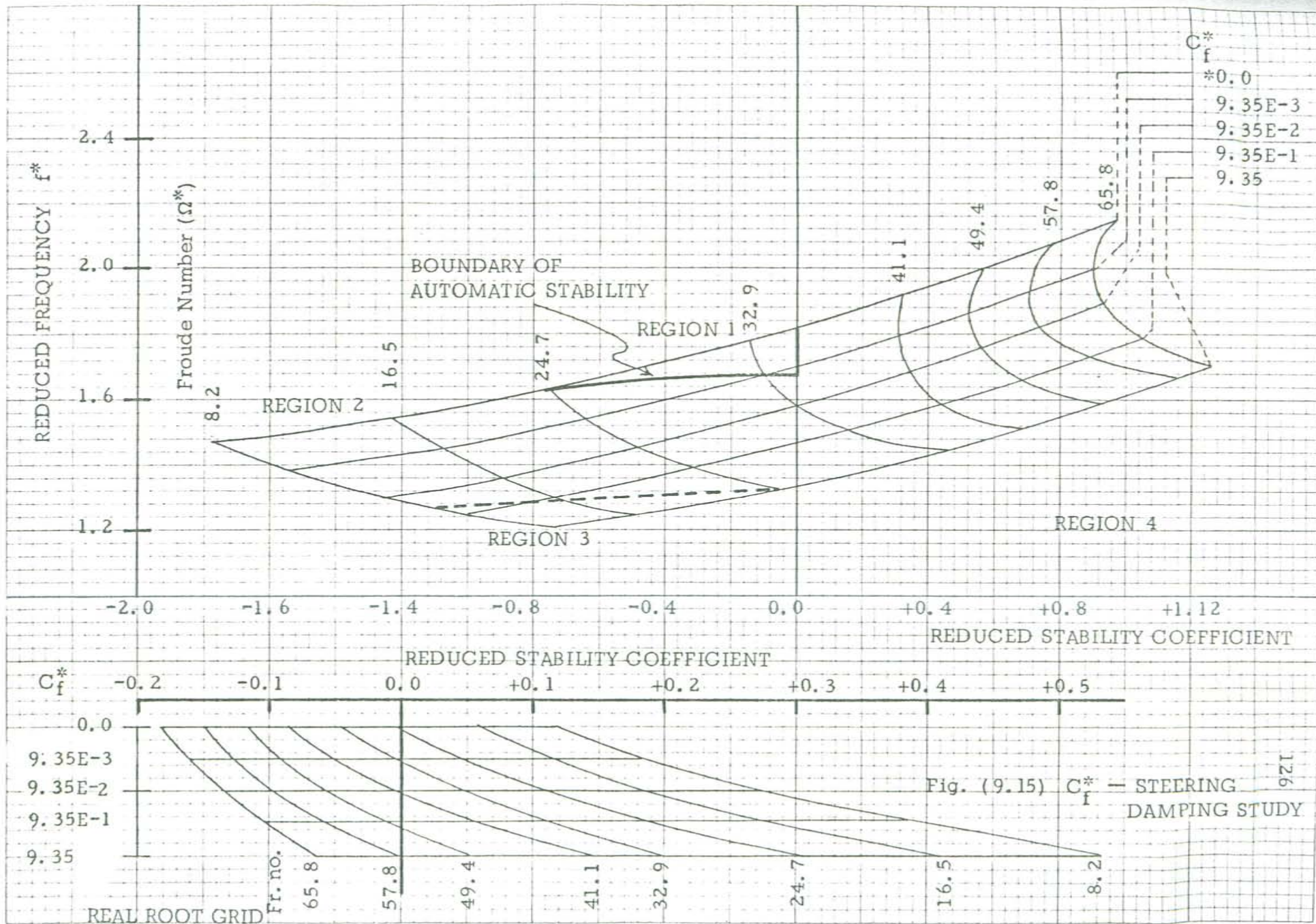

Fig. (9.15) C_f^* — STEERING DAMPING STUDY

CHAPTER 10

EXPERIMENTAL INVESTIGATIONS

Development of Instrumentation

A rather simple but quite satisfactory system was developed to record the motorcycle performance on the road. Since θ and ϕ completely define the motorcycle orientation, an attempt was made in the initial stages to develop suitable instrumentation to record both these angles. A potentiometer pickup on a mechanical extension was used to measure steering angle θ (Fig. (10.1)). This arrangement stayed as such in principle even afterwards, though the location of the potentiometer was changed when an experimental model with variable steering head was tested. In this machine it was found that for extreme positions of steering head configuration (rake and trail), the front system interfered with mechanical extension. The potentiometer was relocated in front of the handle bar (Fig. (10.2-a)).

For the calibration of steering angle θ , a graduated arc, its center coincident with the steering axis, was used. This arc was fixed relative to the rear system and a pointer, attached to the rotating front system, indicated the steering angle θ .

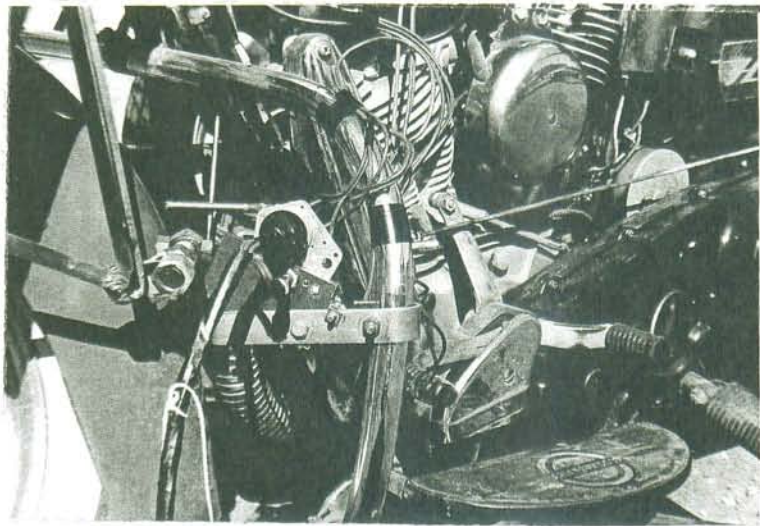

Fig. (10.1) Steering Pickup on Mechanical Extension
(Production Model)



Fig. (10.2) Relocated Steering Pickup on Experimental Model
with Variable Steering Geometry (Trail Setting)



Fig. (10.2-b) Variable Steering Head (Rake Angle Setting)



Fig. (10.2-c) The Experimental Model Test Machine of the Harley Davidson Motor Co.

For the measurement of angle of lean ϕ , at first an accelerometer was tried. The accelerometer was mounted on the rear fender and the gravity component corresponding to the lean of the motorcycle was supposed to give the value of ϕ on a predetermined calibrated scale. This was true, but the accelerometer was also picking up, in addition to the gravity component, the lateral acceleration of the motorcycle and the vibrations from the engine, thus completely obscuring the small angle of lean ϕ . So, a device immune to acceleration was necessary, and a gyroscope was tried (Fig. (10.3)). In the beginning, the gyroscope seemed to work satisfactorily but it was soon discovered that the gyroscope failed to retain its orientation every now and then and began to gyrate ceaselessly. This may be because an accessory known as self-righting mechanism was missing in the gyroscope. It is believed that a rate gyro or any other expensive gyro would have been the most suitable device to measure ϕ . The use of gyro had another advantage. The police model of the motorcycle uses a radio where the gyro was mounted, and the gyro replaced this radio by about an equal weight without changing the motorcycle configuration.

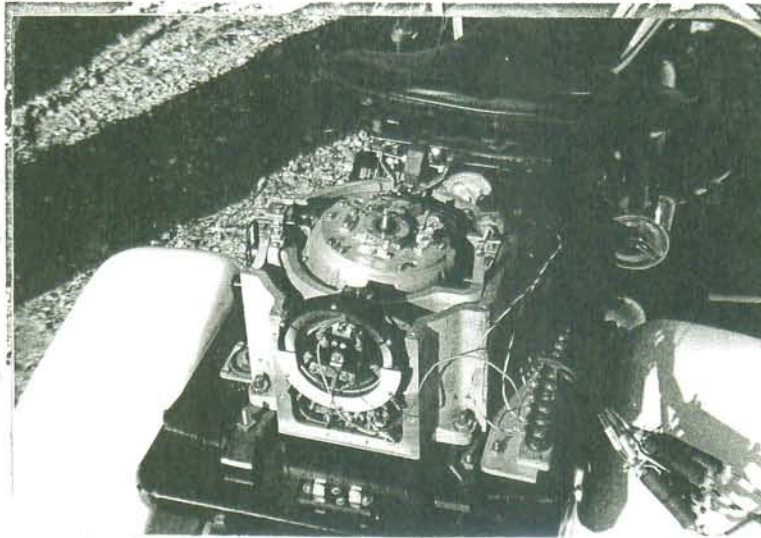

Fig. (10.3) Gyroscope on the Rear Fender of a Production Model

Since an expensive gyro could not be procured, the use of a third wheel was attempted (Fig. (10.4)). The relative rotation of the rectangular frame holding the third wheel with respect to the rear system of the motorcycle was calibrated to give ϕ . The magnitude of ϕ was picked up by a potentiometer mounted on the frame of the third wheel (Fig. (10.5)). The calibration was done by a plumb pendulum. The third wheel with normal tire pressure was apt to bounce on the road. But with soft tire on it, the bouncing could be reduced materially. Loading the third wheel with a sand bag weight with tires also soft, could substantially subside the bouncing.



Fig. (10.4) Third Wheel Assembly on the Production Model

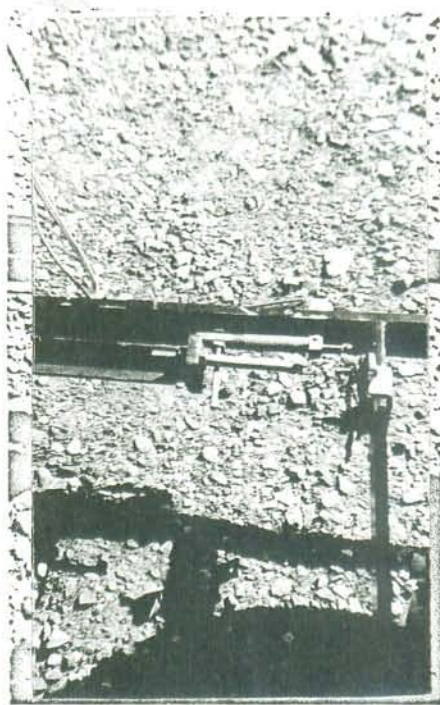

Fig. (10.5) Lean Angle Pickup on the Third Wheel Frame

Fig. (10.6) shows a typical record made with this arrangement. The third wheel was abandoned due to two main reasons, (1) the test machine was not quite the same motorcycle since the drag on the third wheel did affect and alter the natural performance of the machine and (2) the test runs appeared to be dangerous, especially at the higher speeds. The attempt however did not go entirely in vain, since the data thus obtained do substantiate the motorcycle motion phenomena as described in Chapter 3.

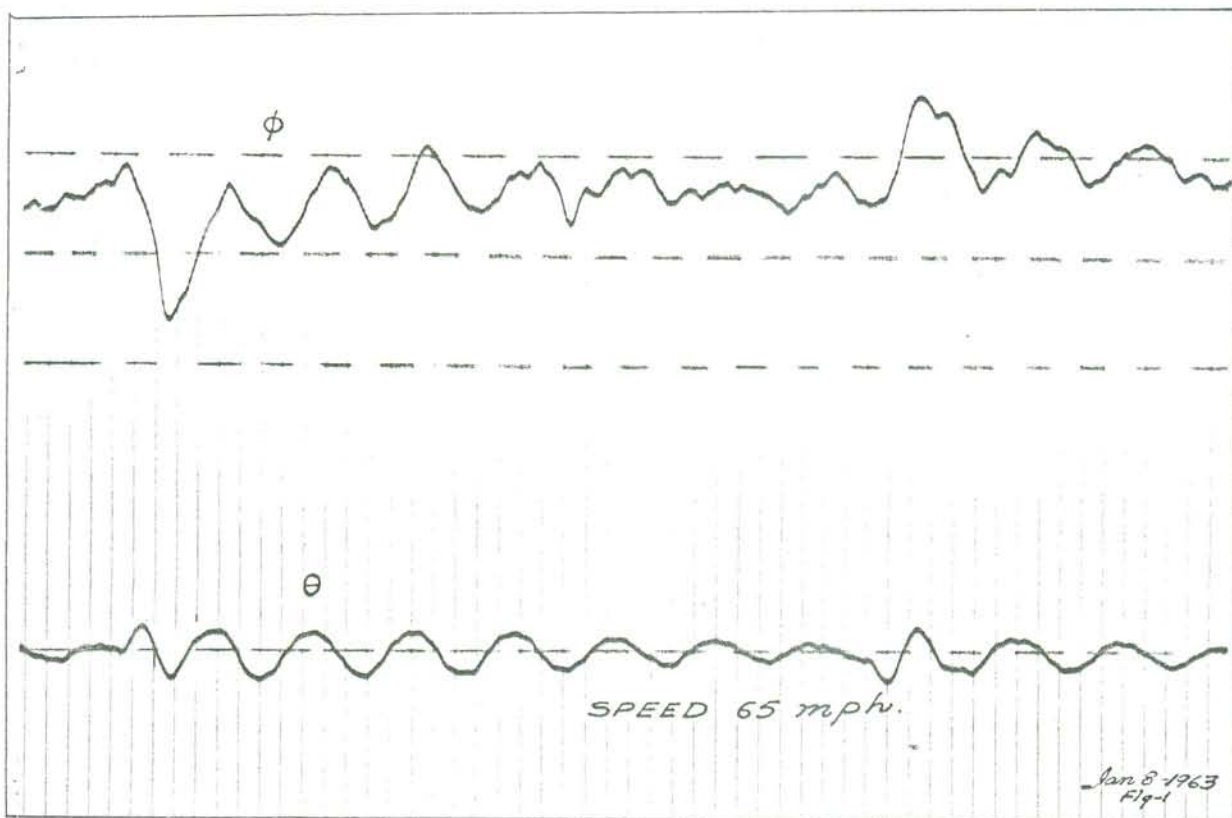

Fig. (10.6) Typical Oscillograph Record of θ and ϕ with the Third Wheel on Production Model with Standard Suspension.

Final Measuring Device

It was noticed that the trace of ϕ from the third wheel pickup was not suitable to compute the damping coefficient and that the trace from steering, if made on a more enlarged scale, would prove very satisfactory to determine the damping coefficient even without the ϕ trace.

In subsequent test runs therefore, ϕ was not recorded. The results that are given in this chapter are based on the record of the steering angle θ alone. Since θ and ϕ are interrelated as described in Chapter 3 and the characteristic equation of the linearized equation of motion is same for both θ and ϕ , the stability with respect to only one variable, either θ or ϕ , is sufficient to represent the stability of the motorcycle motion.

The steering angle pickup was energized by two 1.5-volt batteries which were mounted on the motorcycle itself. A cable connected the steering pickup on the motorcycle to a recording oscilloscope on a slave car (Fig. (10.7)). The signal was fed to the oscilloscope through a suitable filter without any amplification. A schematic of the electric circuit is shown in Fig. (10.8).

Test Procedure

The driver introduced a steering disturbance by a gentle push on the handle bar grip. To minimize the driver input during the test run, the driver removed his hands from the handle bar and allowed the



Fig. (10.7) An Actual Test Run, The Test Motorcycle Following The Slave Car Closely at the Same Speed

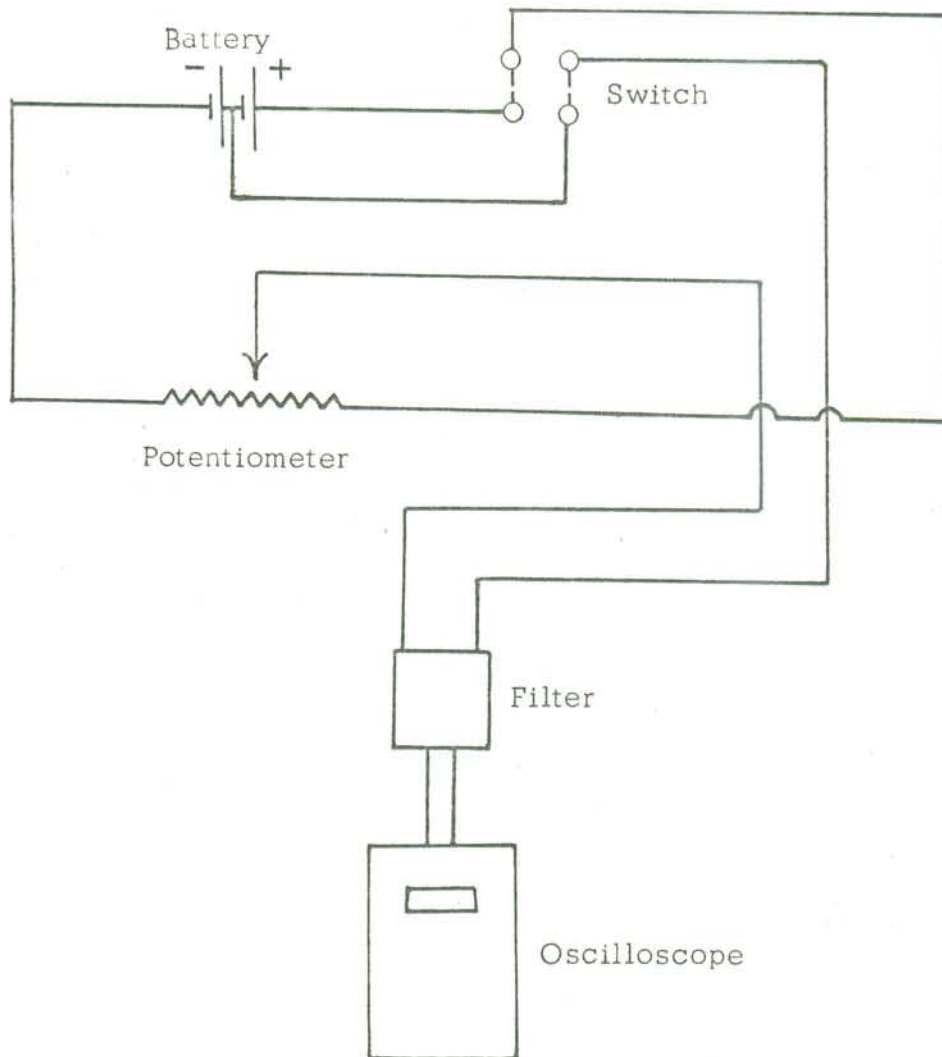

Fig. (10.8) Schematic of Recording Circuit.

machine to stabilize itself on its own (Fig. (10.9)). Only in situations when the motorcycle appeared to be going out of control, did the driver grasp the handle bar again. The motorcycle was run at a safe distance behind the slave car at very closely the same speed as that of the car. During each run, the speed of the motorcycle was maintained as nearly constant as possible. Several recordings were made for each run, and the runs were made over a range of road speeds.



Fig. (10.9) An Actual Test Run. Driver Minimized His Input by Removing His Hands From the Handle Bar.

Computation of Damping Coefficients

The decay of the steering oscillation is according to the relationship

$$\theta = \rho e^{\alpha\tau} \quad (10.1)$$

where θ is the amplitude of oscillation (steering angle) read on the envelope of the peaks on the oscillograph record, ρ an arbitrary constant depending on the initial disturbance and α the factor governing the decay or growth of the oscillations.

By reading any two arbitrary points on the oscillograph record, two relations can be obtained in which, with θ and τ known, there are two unknowns, ρ and α .

$$\theta_1 = \rho e^{\alpha\tau_1} \quad (10.2)$$

$$\theta_2 = \rho e^{\alpha\tau_2} \quad (10.3)$$

α , the damping coefficient, is invariant for a given motorcycle situation whereas ρ is not, since it depends on the initial disturbance. The term of importance and concern here is α , since it represents the tendency of the motorcycle to stabilize itself after it is disturbed. A negative value of α indicates, as pointed out in Chapter 9, that the machine is stable, since the right hand side of equation (10.1) will tend to zero as τ increases. A positive value of α indicates instability since, no matter how small ρ is (ρ can be made as small as desired by making initial disturbance small), the right hand side will grow without limit as τ increases without limit. If however $\alpha = 0$, the motorcycle is like an undamped pendulum with no tendency on its own to damp out the oscillation.

The fact that the trace of θ is oscillatory, means that α is a complex quantity. The imaginary part represents the frequency of oscillation and the real part its damping. Since points are read on the envelope of the peaks of θ -trace, the equations (10.2) and (10.3), when solved for α , will give the real part of the complex quantity representing the damping. The method of reading the points is shown on a typical oscillograph in Fig. (10.10).

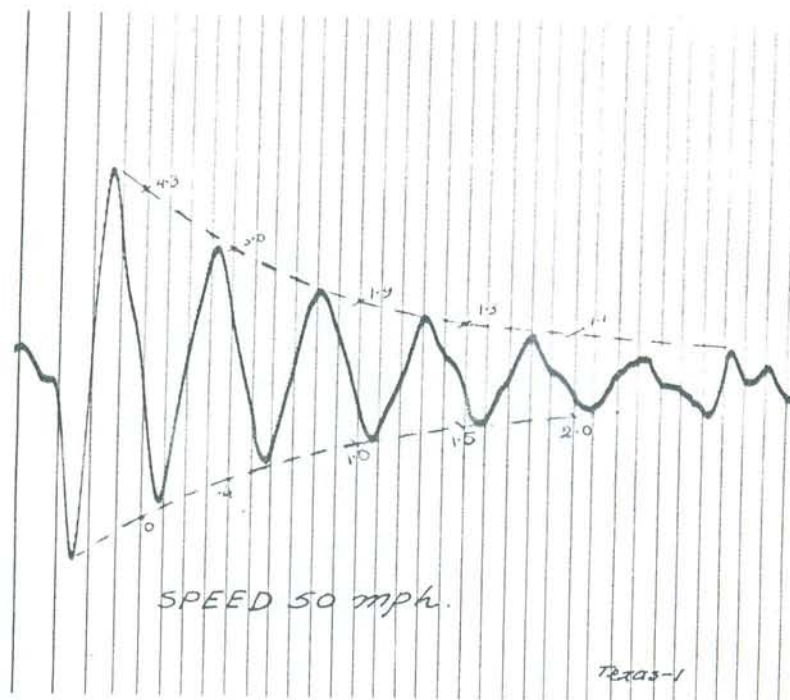

Fig. (10.10) A Typical Run on Production Model Illustrating the Method to Read Points for Computation of Damping Coefficient

Equations (10.2) and (10.3) give

$$\alpha = \frac{\ln \theta_1 - \ln \theta_2}{(\tau_1 - \tau_2)} \quad (10.4)$$

The value of τ can be read on the oscillograph record taking arbitrarily any instant as zero, since in the equation (10.4), only a difference term $(\tau_1 - \tau_2)$ is involved.

Initial Divergence and Subsequent Damping

In some test runs the motorcycle displayed two distinct tendencies. In the beginning, immediately after the steering disturbance was given, the oscillations had a tendency to grow before the damping started. This initial character is named as initial divergence and the damping that appeared afterwards is named as subsequent damping. In few cases, the initial behavior is not a divergence but a damping at a rate slower than that of the subsequent damping. Fig. (10.11) and Fig. (10.12) illustrate two typical traces of the two situations described above.

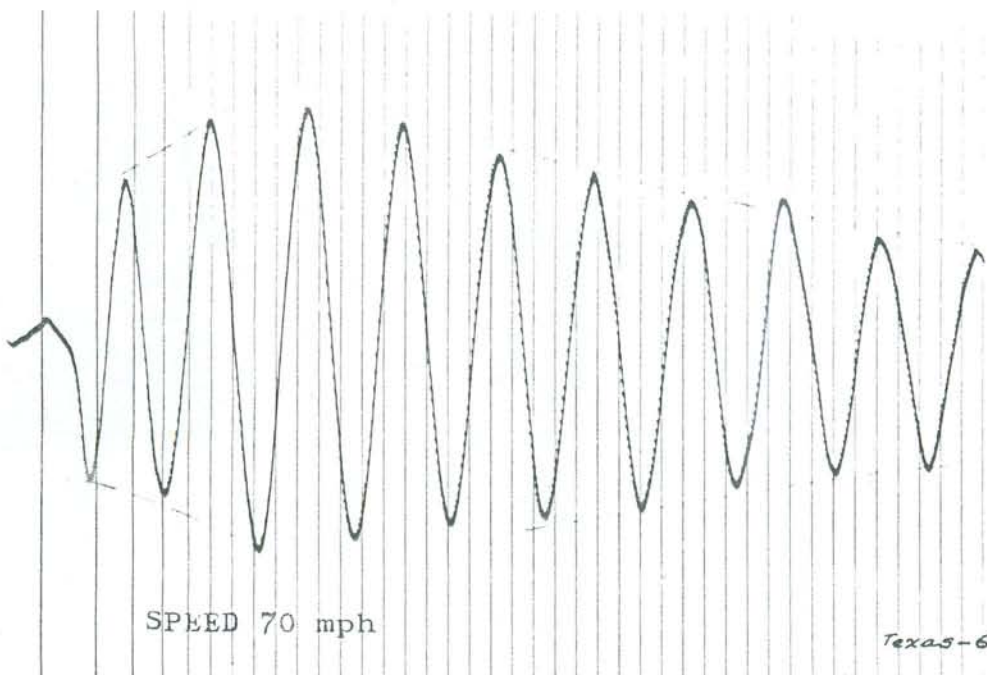

Fig. (10.11) A Typical Oscillograph Record of Production Model, Illustrating Initial Divergence.

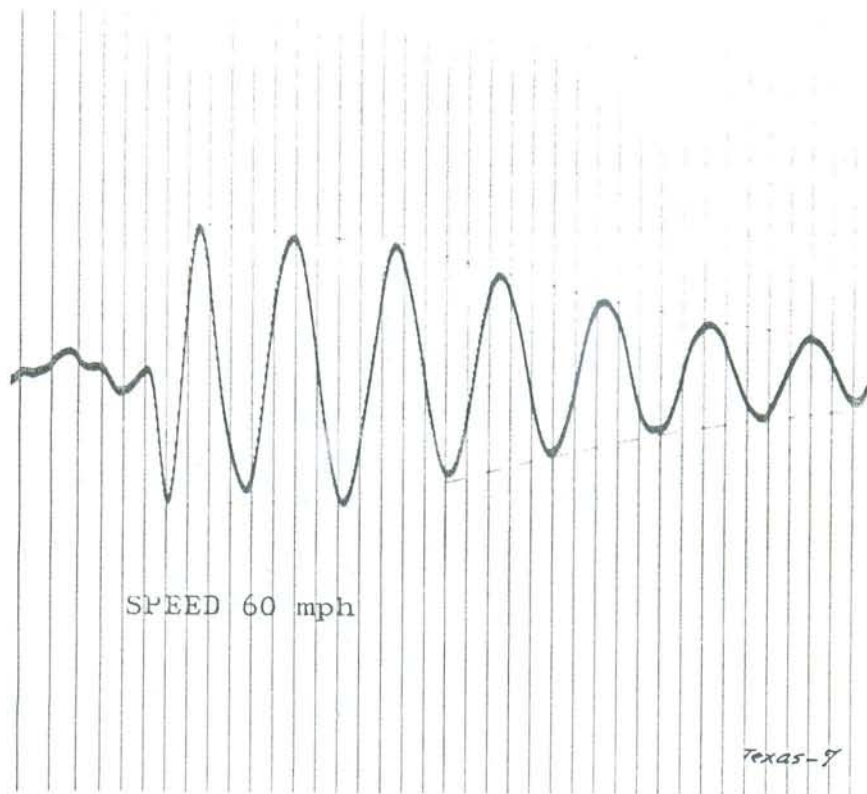

Fig. (10.12) A Typical Oscillograph Record of Production Model Showing Initial Behavior as a Damping at a Rate Slower than that of Subsequent Damping.

The Test Variables

The effect of the following variables was investigated in the road tests:

1. Tire parameters
 - (a) Pressure
 - (b) Brand
2. Steering Damping
3. Weight distribution on rear system
4. Position of driver on the machine
5. Inertia of the front system
6. Moment of inertia of the front wheel affecting the gyroscopic effect
7. Rake
8. Trail

These are by far not all the variables that can be investigated to study their influence on motorcycle performance. But they are the ones which can be readily changed without bringing about any change in the design and manufacture technique of the production machine. The last two variables could be investigated only because the experimental division of the Harley Davidson Motor Company developed an experimental model with variable steering geometry. In this machine rake angle and trail could be changed independently.

The results of the test runs are presented graphically in Fig. (10.15) through Fig. (10.35). The results on Fig. (10.15) through Fig. (10.24) are of the test runs carried out at Madison, Wisconsin. The results of the runs carried out at San Angelo, Texas, with the help of three tables are shown in Fig. (10.25) through Fig. (10.35). The initial divergence wherever present is shown by broken lines.

There are a number of uncontrollable factors involved in the road tests, which make it exceedingly difficult to assign quantitative significance to the experimental results. Besides, the motorcycles tested were not measured for their geometrical, mass, and inertia constants to warrant any quantitative information. The reproducibility of the test runs is somewhat limited. But the data do indicate qualitatively the characteristics of the motorcycle

performance, and the general character of the motorcycle behavior is satisfactorily reproducible (Runs 10 and 10-a on Fig. (10.30)).

Results and Conclusions

The following general conclusions are drawn from the road tests.

1. A motorcycle is more stable at the lower test speeds than at the higher test speeds in most of the motorcycle situations.
2. The frequencies of steering oscillation at all speeds remain very close to 2 cycles per second, and therefore they have not been plotted on the graphs representing the experimental data. The frequency at the lowest test speed (40 mph) is slightly less than 2 cps, and at the highest test speed (80 mph), it is slightly over 2 cps. The frequencies not only remain close to 2 cps even in different motorcycle situations, but also show the same trend of minor variation over the entire range of test-speeds.
3. Rigid suspension does not make significant difference in the motorcycle performance with respect to the stability considerations and almost none in the general trend. However, the stability with rigid suspension is slightly better than that of the standard production model (comparing

Figures (10.15), (10.16), and (10.19) with Figures (10.20), (10.21), and (10.22) respectively).

4. Motorcycle performance does not change substantially with the change in either the rake angle or the trail. All the combinations of three rake angles, 29.1° , 31.6° , and 31.1° and three trails, 5.75", 6.90", and 8.00" were tested. The combination of 29.1° rake angle and 5.75" trail turned out to be the best of all, and the combination $34.1^\circ - 8.00"$ poorest with regard to stability. In some cases a critical speed is suggested where the stability is minimum.
5. The experimental model, in all the test setting of the steering head (including the poorest), is more stable than the production model using the same pair of tires.
6. Effect of increased moment of inertia of the front wheel (i. e., the increased gyroscopic effect) is helpful in all the circumstances tested. This effect is more predominant at the higher test speeds. The effect is so significant, that it tends to make the motorcycle more stable at higher speeds than at lower speeds contrary to the usual trend (Figures (10.19), (10.22), and (10.24), and runs 22 and 23 compared with runs 22-a and 23-a respectively in Table (10.3).

7. The tightening of steering damper decreases the stability. However, at higher speeds, the steering damper is often helpful.
8. The smooth tires make the machine sensitive to additional weights on the rear fender.
- 9-a. When the cause of instability is quick steering response resulting in "shaking of its head," a steering damper is very helpful (Fig. (10.13-a) and Fig. (10.13-b)).

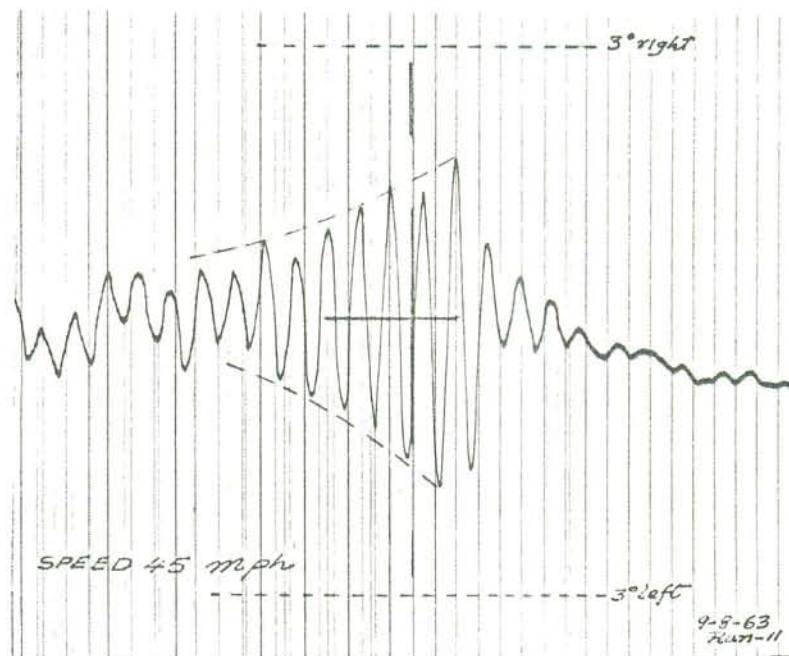

Fig. (10.13-a) Production Model With Standard Suspension; Smooth Tires; Front Tire - 13 psi; Rear Tire - 16 psi; 53 lbs on Rear Fender; No Steering Damper.

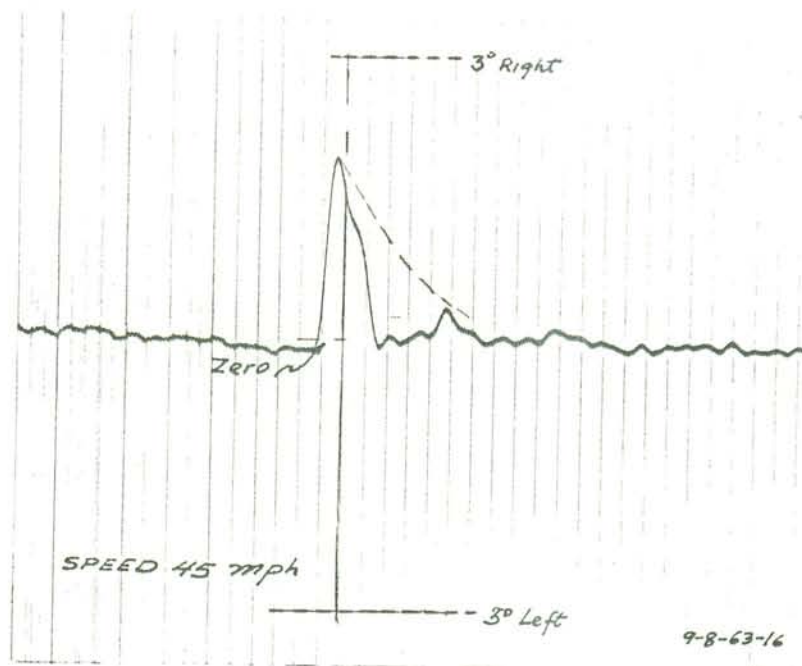

Fig. (10.13-b) Same Motorcycle Situation as that in Fig. (10.13-a)
With Steering Damper Turned All the Way Down.

9-b. Situation in Fig. (10.13-a) also improved by increasing the moment of inertia of the front wheel. The resulting increased gyroscopic effect was not so dominant as the steering damper. But as the speed went up, the gyroscopic effect became more significant. The following three oscillograph traces indicate this fact.

10. Weight on the rear fender affects the stability adversely.

11. Soft front tire decreases the stability at all speeds.

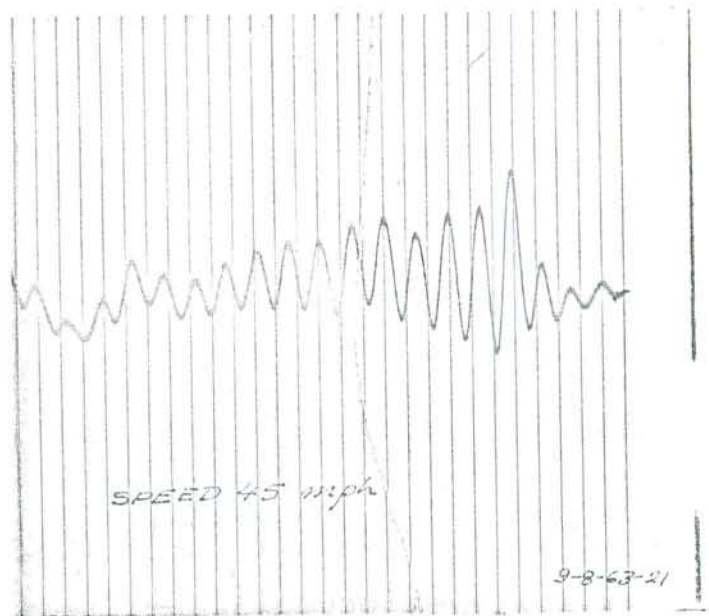

Fig. (10.14-a) Motorcycle Situation Same as That in Fig. (10.13-a); No Steering Damper; Front Wheel Moment of Inertia Increased. Speed — 45 mph.

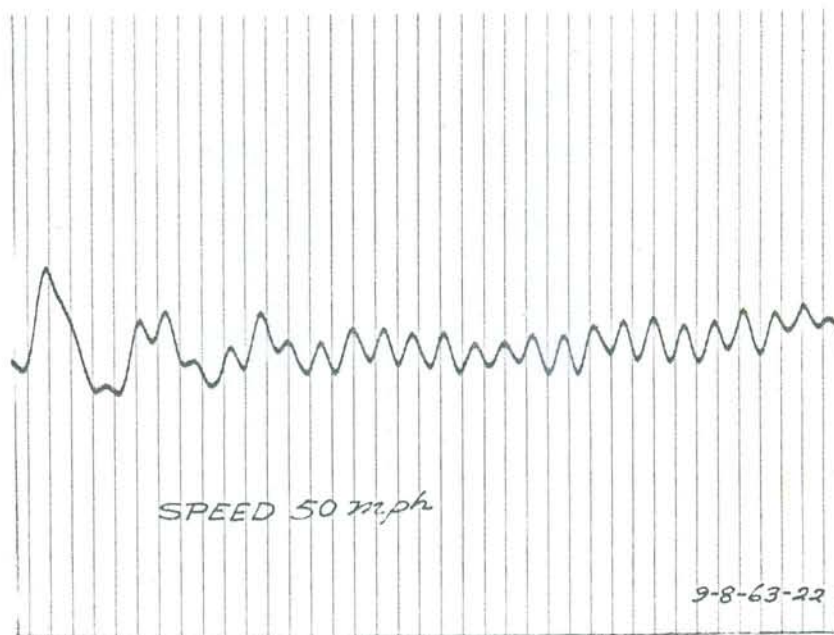

Fig. (10.14-b) Same Motorcycle Situation as That in Fig. (10.14-a). Speed — 50 mph.

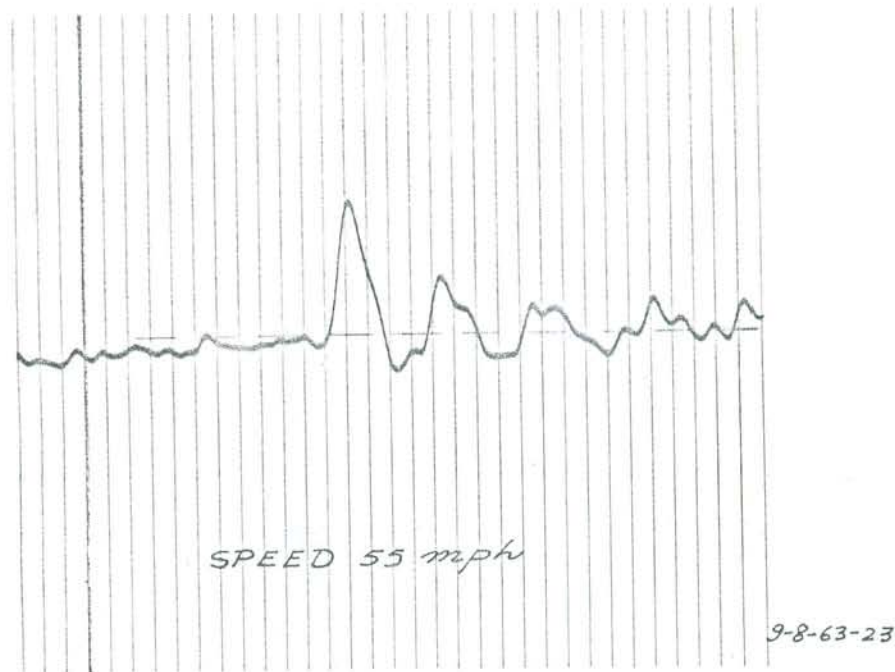

Fig. (10.14-c) Same Motorcycle Situation as That in Fig. (10.14-a). Speed 55 mph.

12. Fig. (10.23) compared to Fig. (10.15), runs 10 and 10-a on Fig. (10.30) compared to all the runs on Fig. (10.25) through Fig. (10.30), and a comparison of run 27 in Series-4 with all the other runs in the same series in Table (10.3), indicate very conclusively that the smooth tires with greater cornering power provide greater stability to a motorcycle than do the other tires.
13. The results of runs 2, 3, 4, and 5 in Fig. (10.26) and Fig. (10.27), suggest that it helps to have, at higher speeds, a front tire with higher cornering power, but at lower speeds on the contrary, a front tire with smaller cornering power, as compared to that of rear wheel.

14. Old tires, if uniformly worn, do not seem to affect the stability adversely (run 12 in Fig. (10.30) compared to run 1 in Fig. (10.25)).
15. Moving the weight of the driver forward results in an improvement.

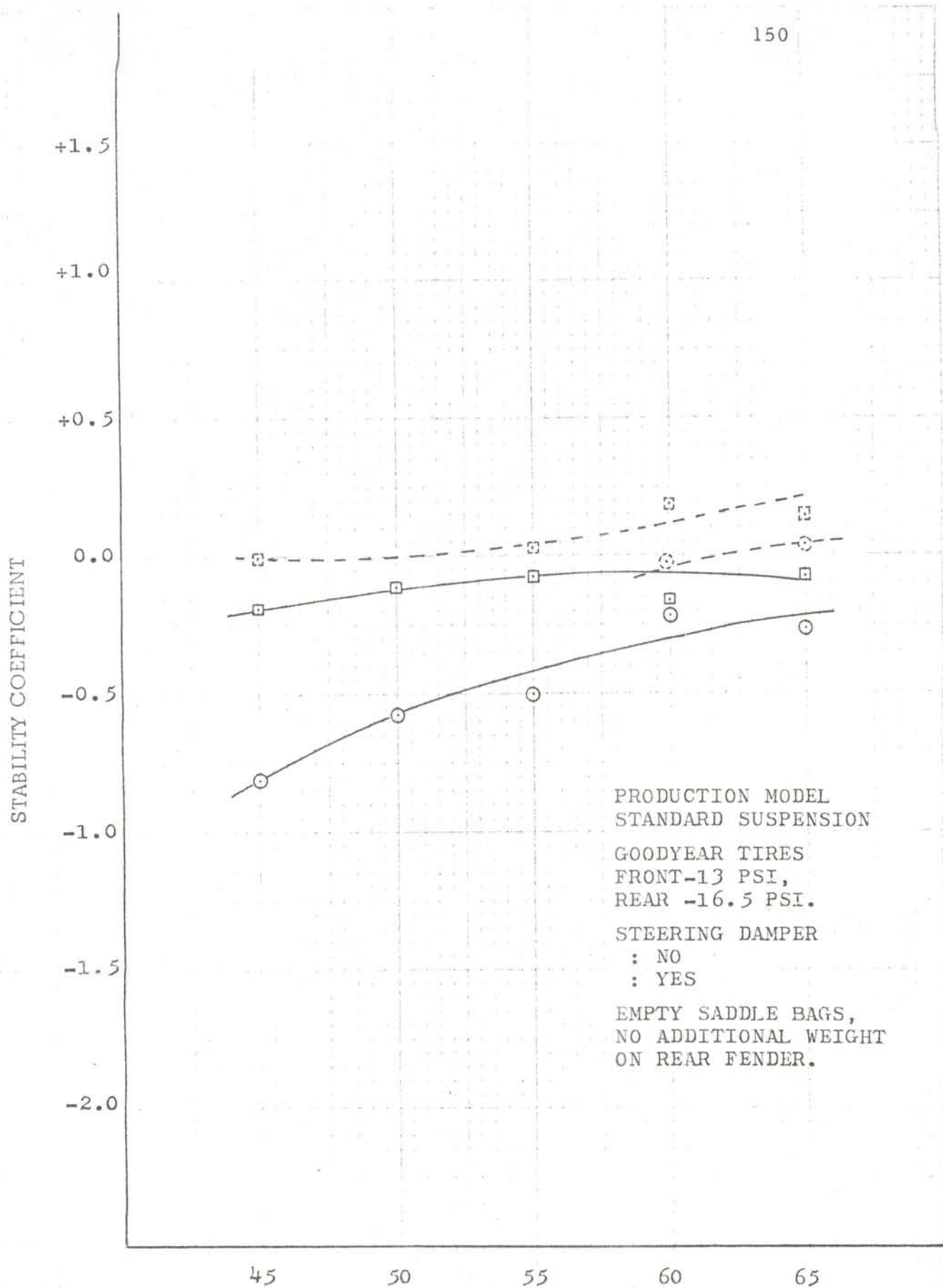

Fig. (10.15) SPEED IN MILES PER HOUR

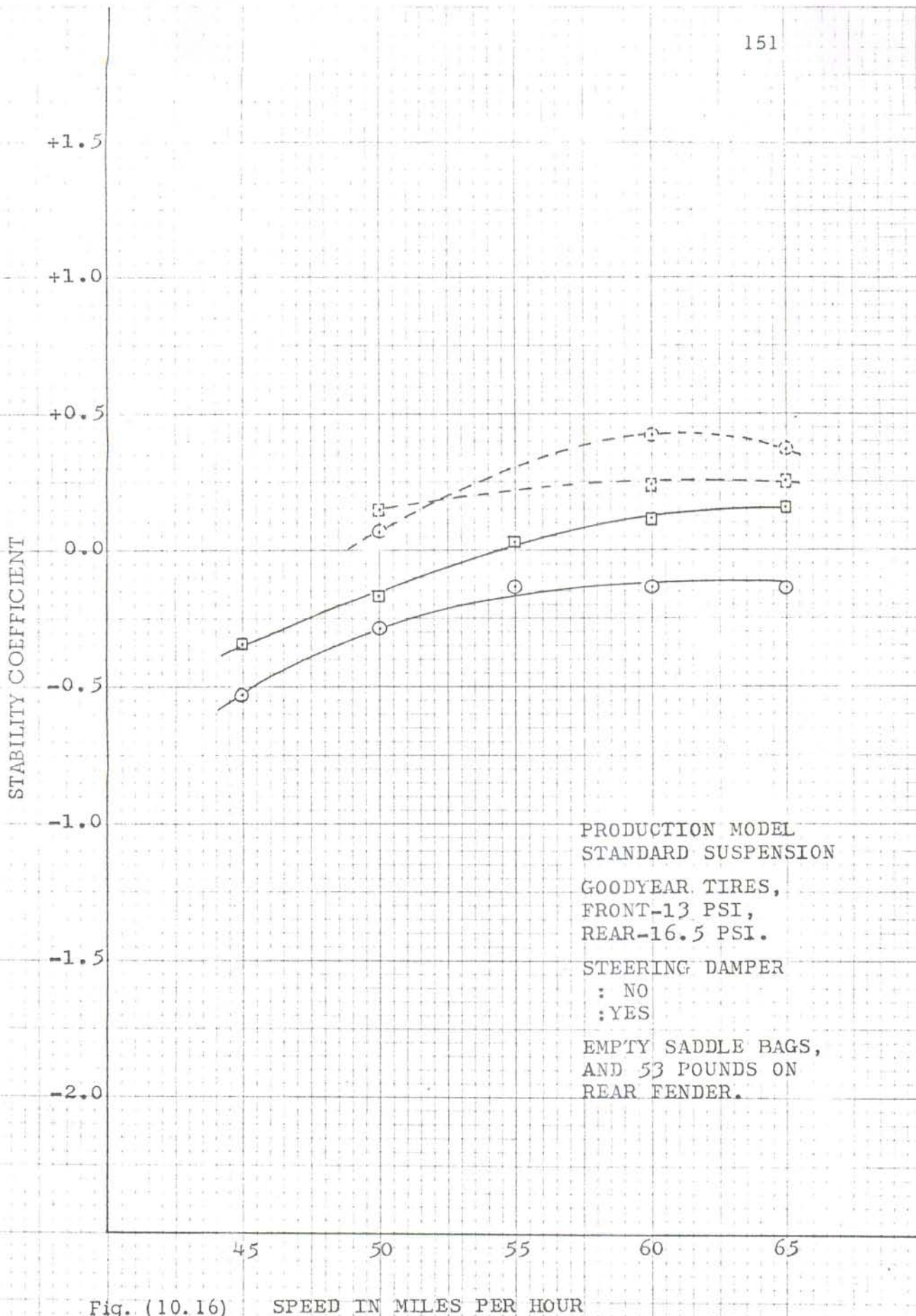

Fig. (10.16)

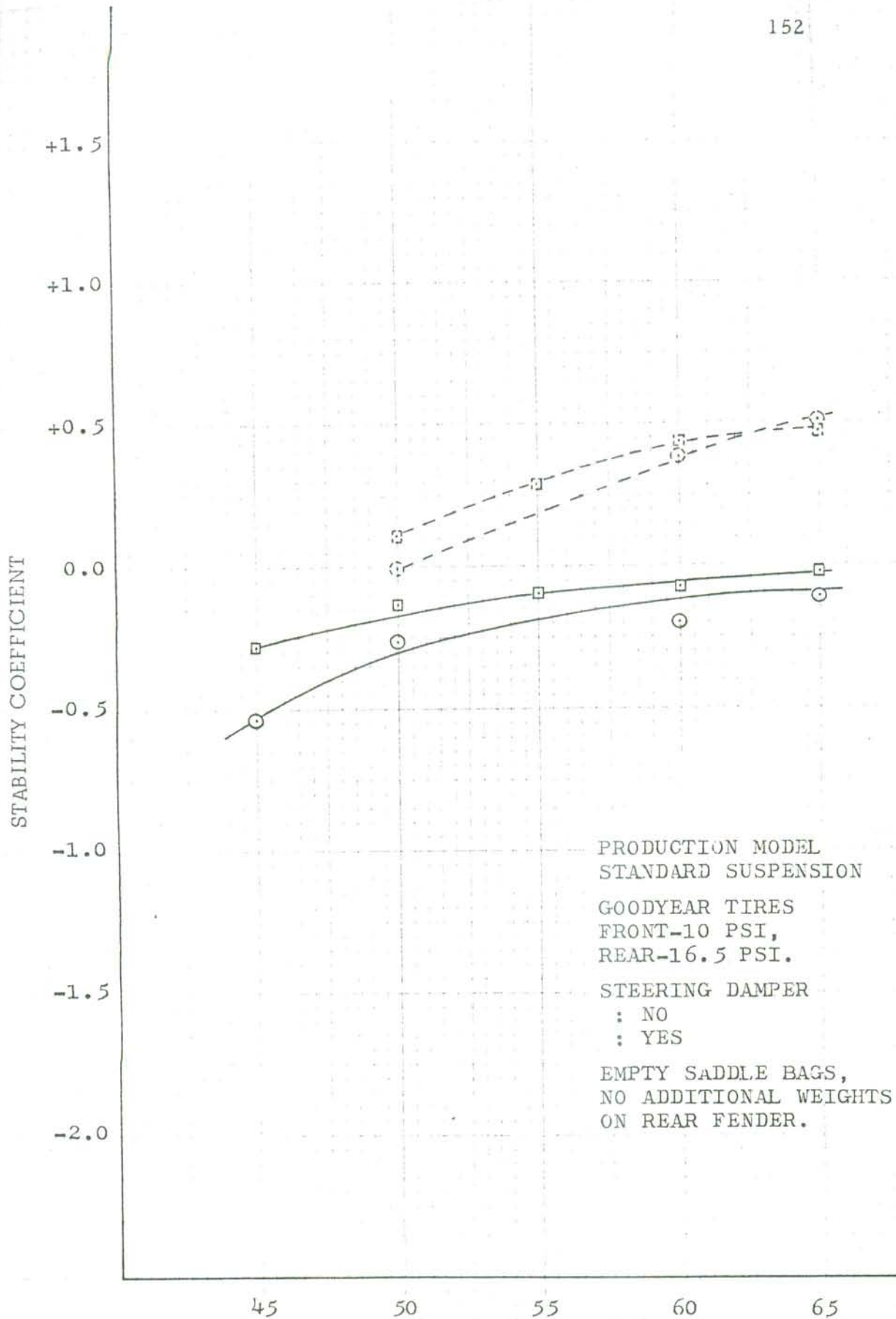

Fig. (10.17) SPEED IN MILES PER HOUR

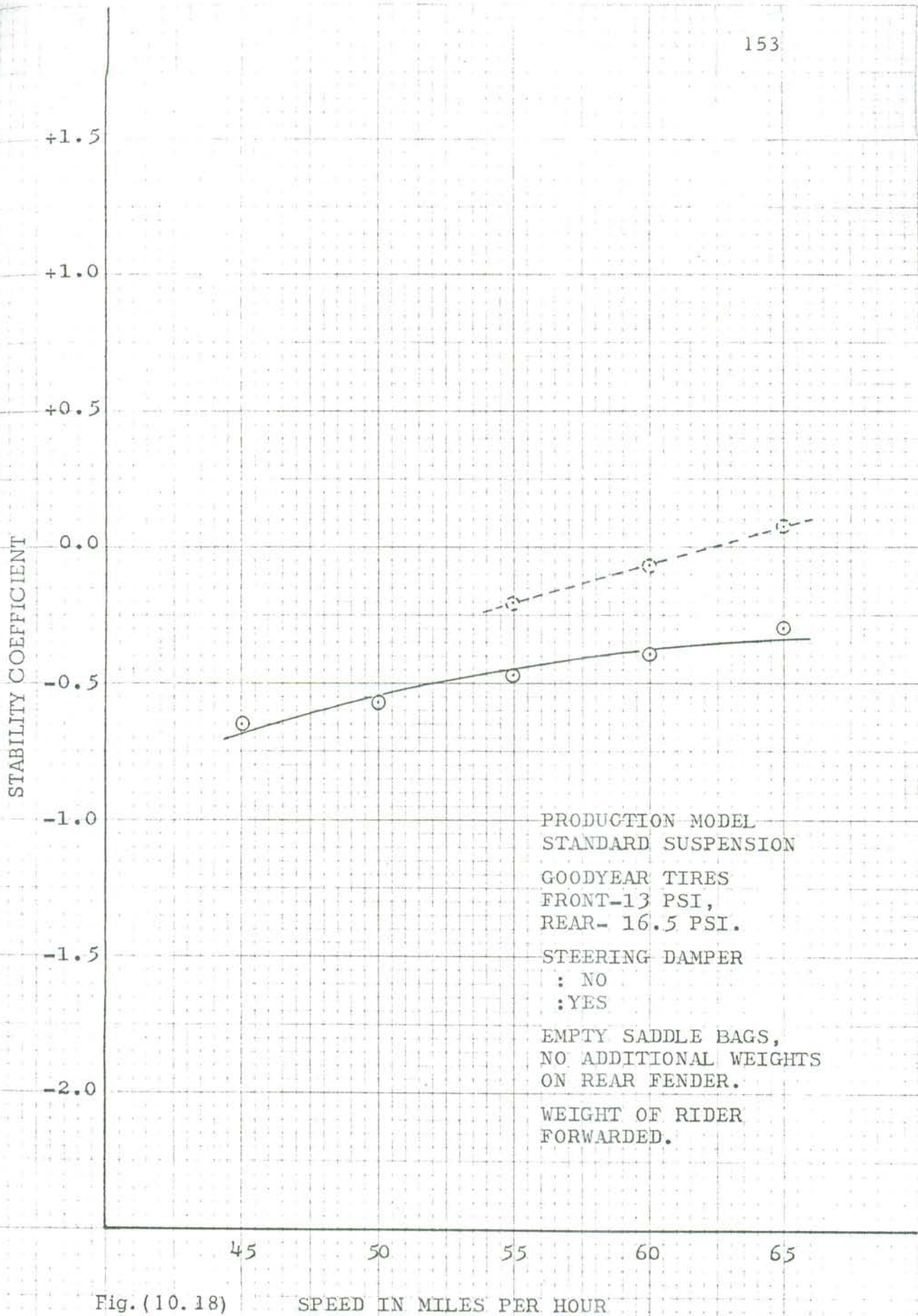

Fig. (10.18)

SPEED IN MILES PER HOUR

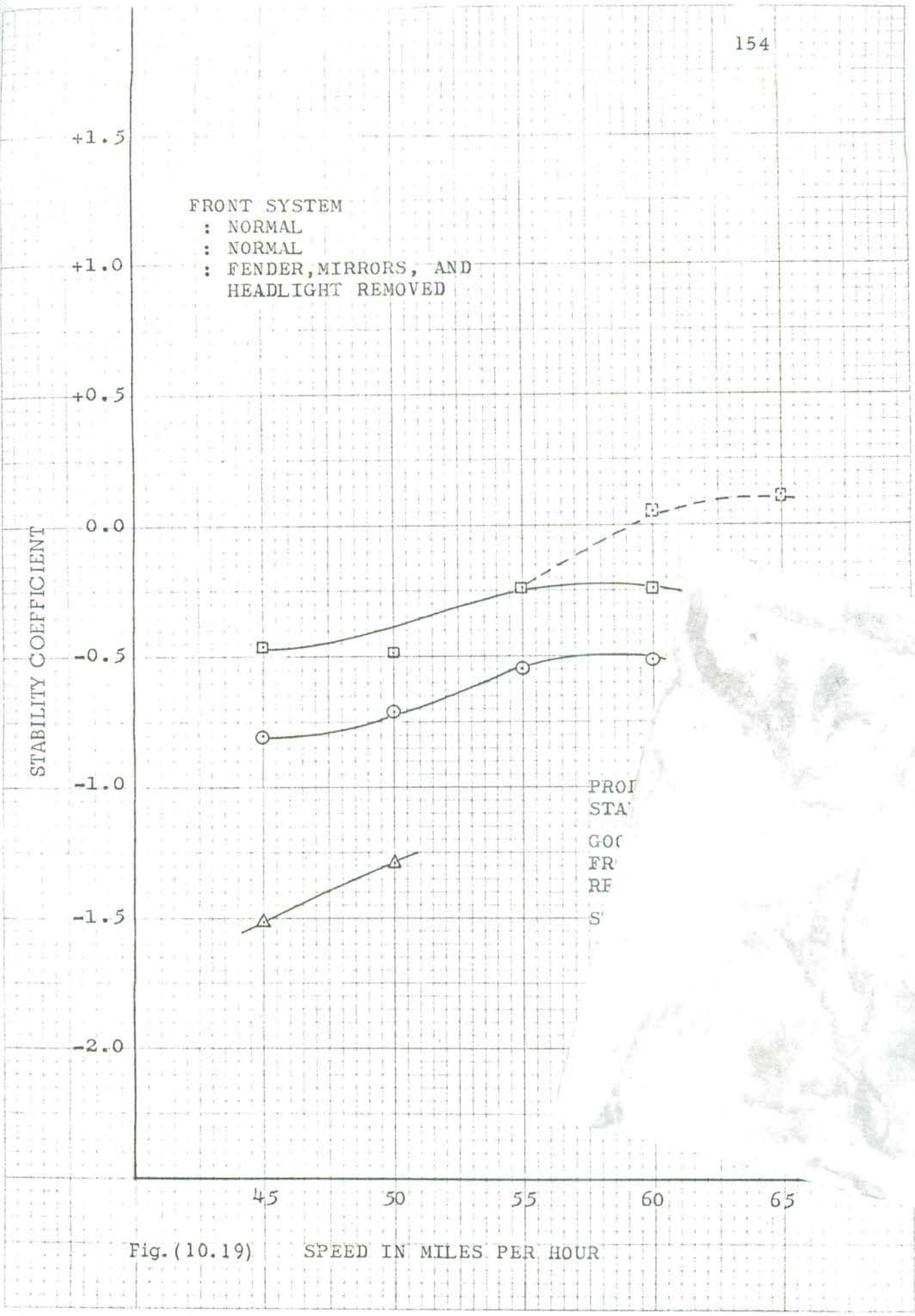

Fig. (10.19) SPEED IN MILES PER HOUR

STABILITY COEFFICIENT

+1.5
+1.0
+0.5
0.0
-0.5
-1.0
-1.5
-2.0

PRODUCTION MODEL
RIGID SUSPENSION

FRONT-13 PSI,
REAR -16 PSI.

STEERING DAMPER
: NO
: YES

45

50

55

60

65

Fig. (10.20) SPEED IN MILES PER HOUR

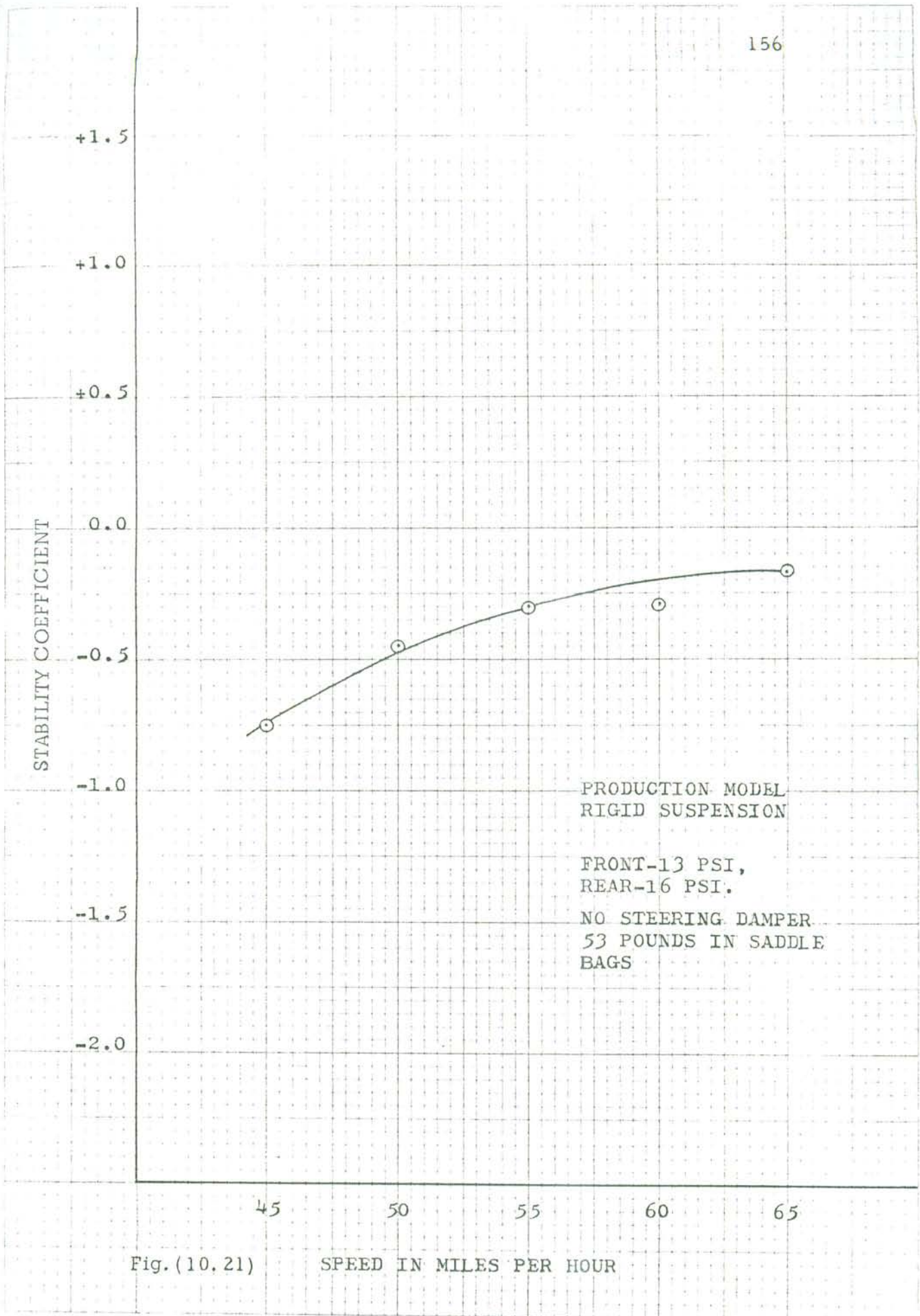

Fig. (10.21)

SPEED IN MILES PER HOUR

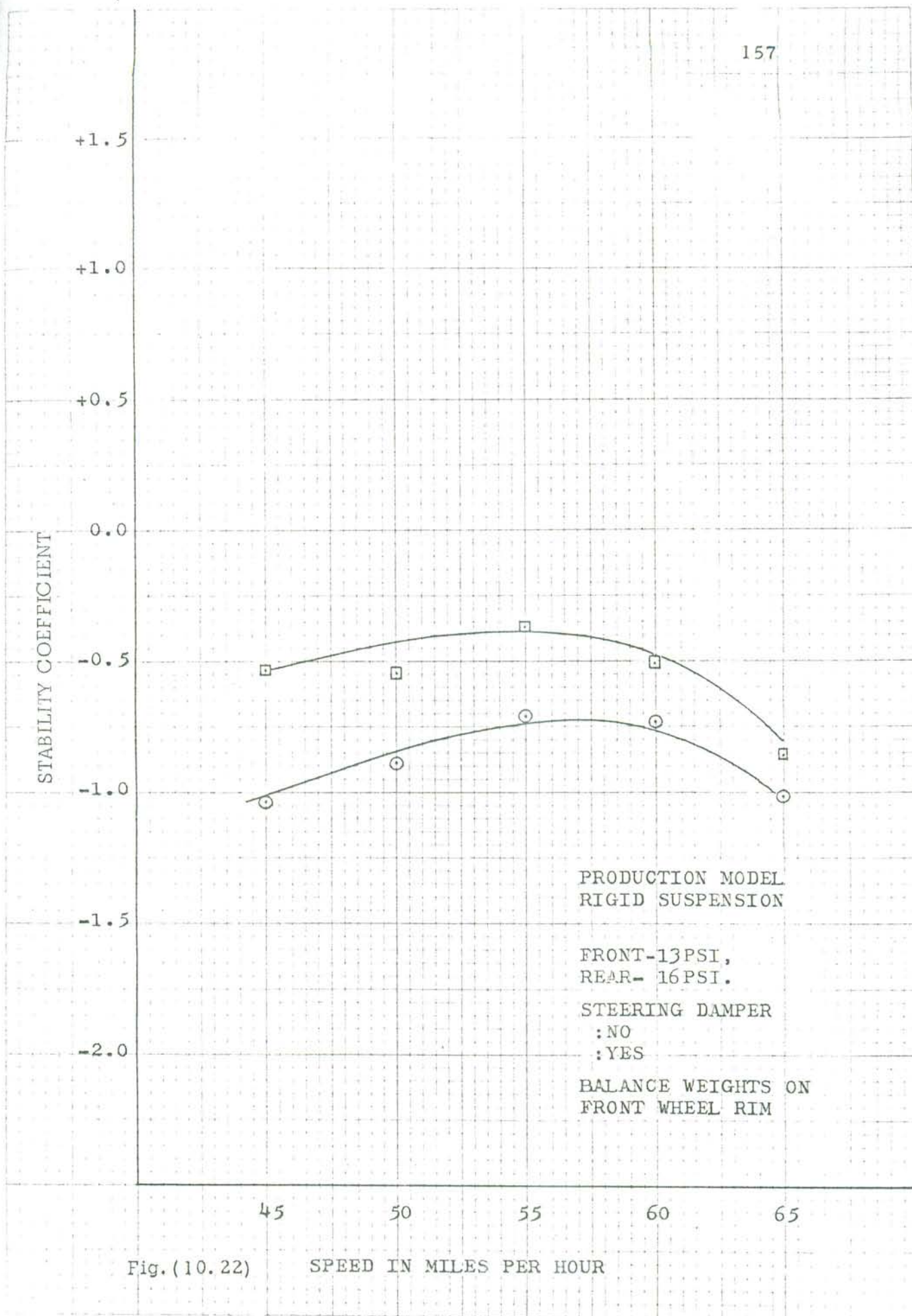

Fig. (10.22)

SPEED IN MILES PER HOUR

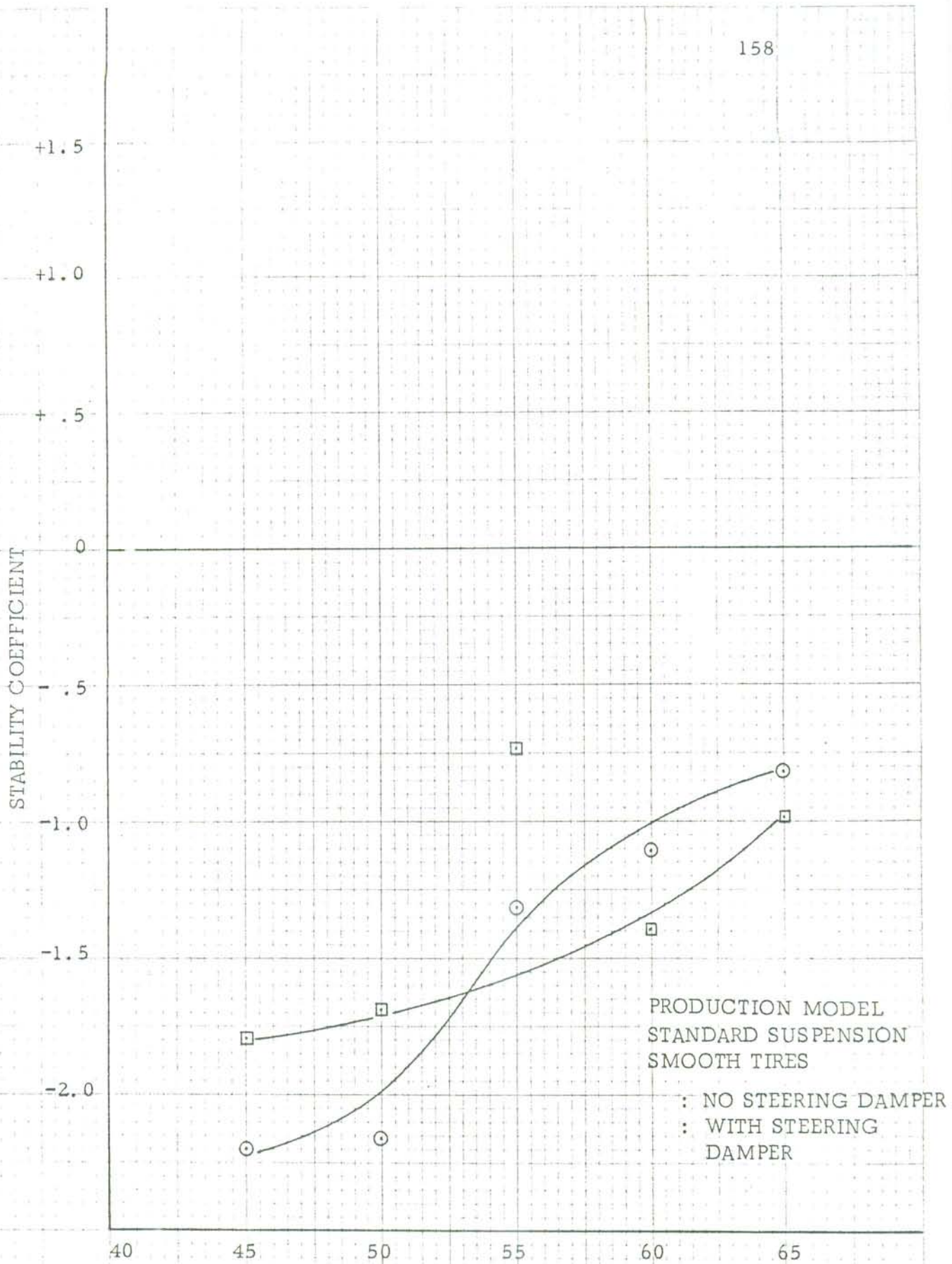

Fig. (10.23)

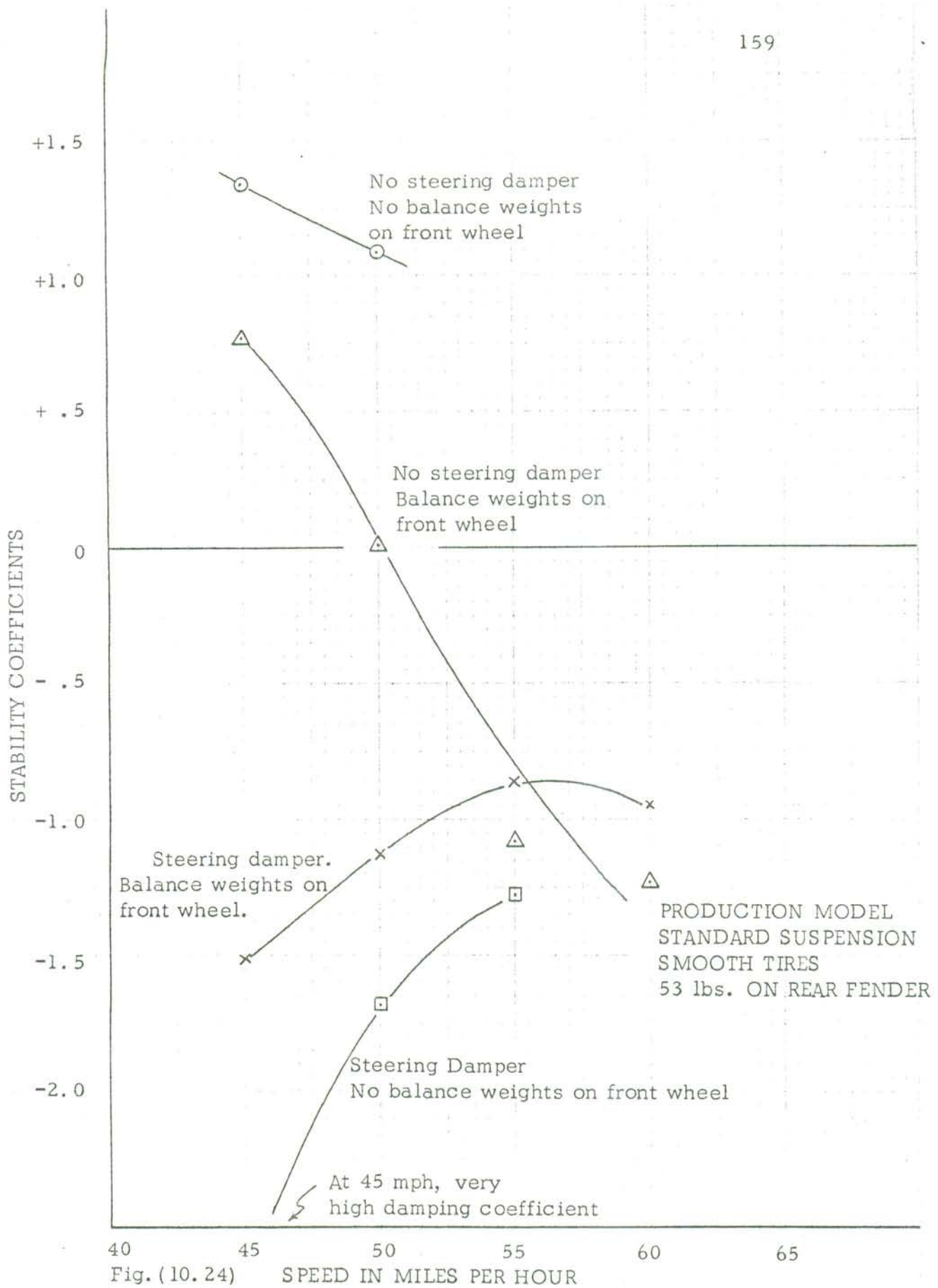

Fig. (10.24) SPEED IN MILES PER HOUR

TABLE 10.1
SPECIFICATIONS OF TEST RUNS

	Run Machine	Front Tire	Rear Tire	Rake deg.	Trail Inches
	1	Goodyear	Goodyear		
	1-a ¹	Super Eagle	Super Eagle		
	2	Goodyear 63-332-E	"		
	3 ²	Goodyear Super Eagle	Goodyear 63-332-E		
	4	"	Goodyear 63-332-A		
SERIES 1	5	Goodyear 63-332-A	Goodyear Super Eagle		
	6	Firestone	Firestone		
	7	U. S. Royal 1	U. S. Royal 1		
	8	U. S. Royal 2	U. S. Royal 2		
	9	U. S. Royal 3	U. S. Royal 3		
	10	Smooth	Smooth		
	10-a ³	"	"		
	11	Worn S. E. 1 ⁴	Worn S. E. 3 ⁵		
	12	Worn S. E. 2 ⁵	Worn S. E. 3		

¹ Less Right Saddle Bag

² Machine wobbled even when the driver held the handle bar

³ Run 10 repeated next day for check

⁴ Worn S. E. 1 had too high central ribs

⁵ Worn S. E. 2 and 3 were uniformly worn (S. E. — Goodyear Super Eagle Tires)

TABLE 10.1 (continued) — SPECIFICATIONS OF TEST RUNS

	Run Machine	Front Tire	Rear Tire	Rake deg.	Trail inches	
SERIES 2	13	EXPERIMENTAL MODEL	Goodyear Super Eagle	Goodyear Super Eagle	29.1	5.75
	14		"	"	29.1	6.90
	15		"	"	29.1	8.00
	16		"	"	31.6	5.75
	17		"	"	31.6	6.90
	18		"	"	31.6	8.00
	19		"	"	34.5	5.75
	20		"	"	34.5	6.90
	21		"	"	34.5	8.75
SERIES 3	22	EXPERIMENTAL MODEL	Worn S. E. 1	Worn S. E. 3	29.1	5.75
	22-a*		"	"	"	"
SERIES 4	23	EXPERIMENTAL MODEL	Goodyear Super Eagle	Goodyear Super Eagle	29.1	5.75
	23-a*		"	"	"	"
	24		"	Goodyear 63-332-A	"	"
	25		Firestone	Firestone	"	"
	26		U. S. Royal 1	U. S. Royal 1	"	"
	27		Smooth	Smooth	"	"

* Balance weights on front wheel

TABLE 10-2
STABILITY COEFFICIENTS OF SERIES 1 and 2

Run	Machine	Front Tire	Rear Tire	Damping roots			
				40 mph	50 mph	60 mph	70 mph
1		Goodyear Super Eagle	Goodyear				+ .05093*
			Super Eagle				- .29455
1-a		"	Less right saddle bag			+ .18209*	+ .51263*
							- .11165
2		Goodyear 63-332-E	Goodyear				+ .23392*
			Super Eagle				- .23851
3		Goodyear Super Eagle	Goodyear			- .20975*	+ .27394*
			63-332-E				- .15187
4		Goodyear 63-332-A	Goodyear			+ .43588*	+ .34607*
			Super Eagle				- .55410
5		Goodyear Super Eagle	Goodyear				+ .18302*
			63-332-A				- .24101
6		Firestone	Firestone				+ .65498*
							- .28923
7		U. S. Royal 1	U. S. Royal 1			+ .04520*	+ .07729*
							- .39828
8		U. S. Royal 2	U. S. Royal 2			- .09369*	+ .13673*
							- .27671
9		U. S. Royal 3	U. S. Royal 3			+ .12553*	+ .51974
							- .42738
10		Goodyear Smooth	Goodyear				
			Smooth				- .44537
10-a		"	"				
							- .139010
11		Worn Super Eagle 1	Worn Super				- .61296
			Eagle 3				+ .11907*
							- .18920
							- .62946
							- .37756
							- .14598

PRODUCTION MODEL

TABLE 10-2 (continued) — STABILITY COEFFICIENTS OF SERIES 1 and 2

Run	Machine	Front Tire	Rear Tire	Damping Roots			
				40 mph	50 mph	60 mph	70 mph
12	Production Model	Worn Super Eagle 2	Worn Super Eagle 3	-1.06401	-.673634	+ .08234*	+ .29503*
13		Goodyear Super Eagle	Goodyear Super Eagle	-1.66219	-1.44547	-1.10268	- .28779*
14	EXPERIMENTAL MODEL	"	"	-2.07159	-1.38774	-1.10115	-1.04096
15		"	"	-1.82036	-1.36422	-.94362	0.00000*
16		"	"	-1.72309	-1.33335	-1.10079	-.73155
17		"	"	-1.42097	-1.23601	-.99852	+ .18537*
18		"	"	-1.67152	-1.31001	-.70609	-.67221
19		"	"	-1.87850	-1.46101	-1.06643	-.01592*
20		"	"	-1.75039	-1.46650	-.821302	-.69799
21		"	"	-1.60036	-1.32383	-.87403	+ .50219*
						0.00000	-.67207
							+ .23828*
							-.72039
							+ .20439*
							-.69257
							+1.20547*
							-.66516

* Roots representing initial divergence.

TABLE 10.3
RESULTS WITH EXPERIMENTAL MACHINE

Run	Damping coefficients at 70mph			Damping coefficients at 80mph			
	α_{initial}	Remarks on α_{initial}	α_{second}	α_{initial}	Remarks on α_{initial}	α_{second}	
SERIES 2	13	- .28779	-	-1.04096			
	14	0.00000	-	-.73155			
	15	+ .18537	-	-.67223		Tests at 80 mph were not carried out in this series.	
	16	- .01592	-	-.69799			
	17	+ .50219	-	-.67207			
	18	+ .9290	-	-.71191			
	19	+ .23828	-	-.72039			
	20	+ .20439	-	-.69257			
	21	+1.20547	-	-.66516			
22	0.00000	-	-.53102	+ .40436	-		-.48739
22a	- .03233	-	-.82567	+ .23479	-		-.72093
23	- .34215	-	-.62327	+ .25423	occurs once—not conclusive	-.45446	
SERIES 3 and 4	23a	None*	-	-.89160	+ .70437 0.00000	not conclusive	-.77768
	24	+ .34218 - .20845	not conclusive	-1.04640	+ .90189	-	-.84514
	25	None	-	-.51521	+1.23170	-	-.54372
	26	None	-	-.68984	None	-	-.69054
27	+1.64159	occurs once, not conclusive	-1.18887	+ .29385	-	-1.04042	

*"None" signifies that there was no initial divergence in steering oscillation.

STABILITY COEFFICIENTS

+1.5

+1.0

+0.5

0.0

-0.5

-1.0

-1.5

-2.0

40

50

60

70

80

SPEED IN MILES PER HOUR

PRODUCTION MODEL

RUN	FRONT WHEEL	REAR WHEEL
1	GOODYEAR SUPER EAGLE	GOODYEAR SUPEREAGLE
1a	SAME AS 1; LESS RIGHT SADDLE BAG.	

(Fig. (10.25)

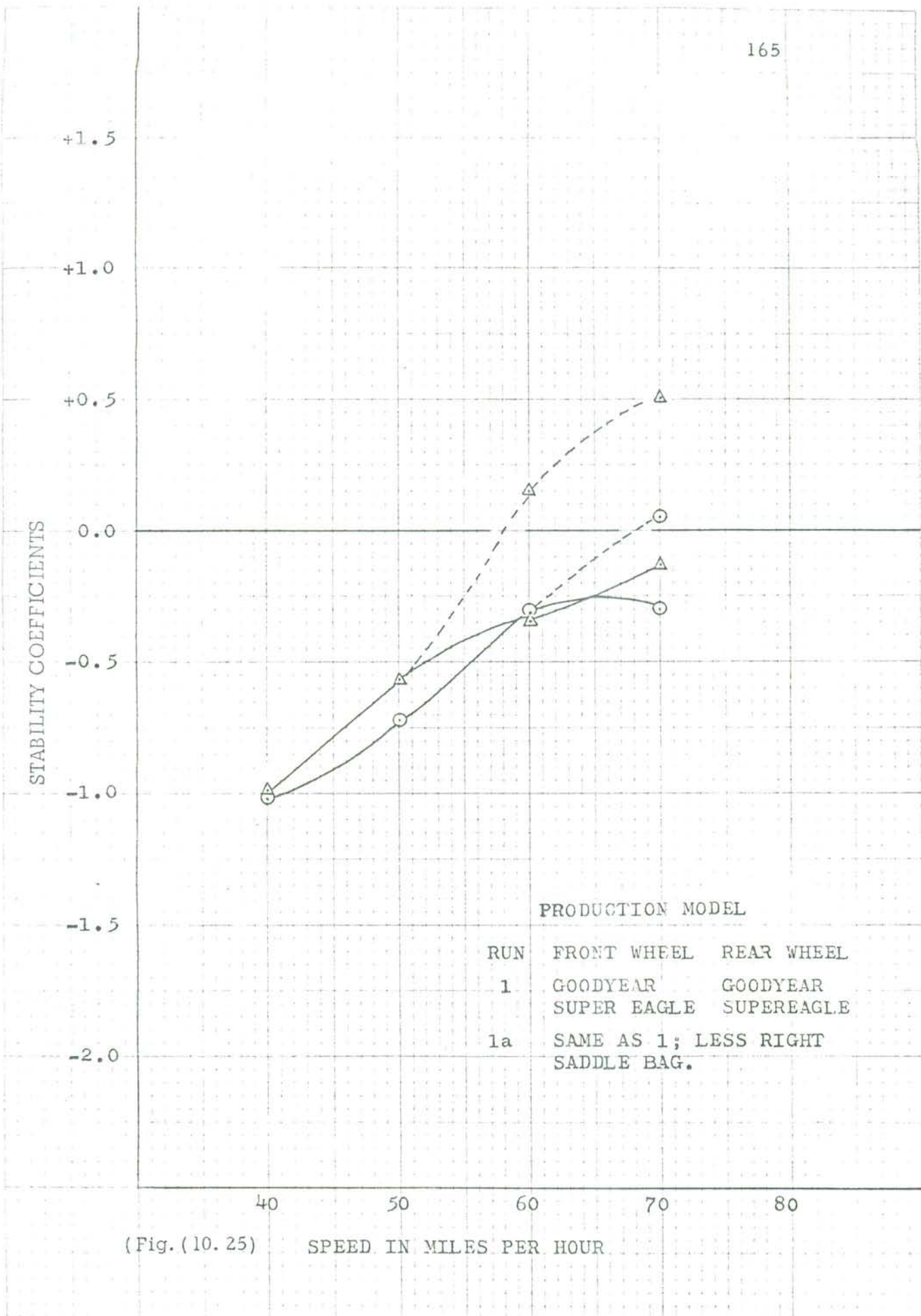

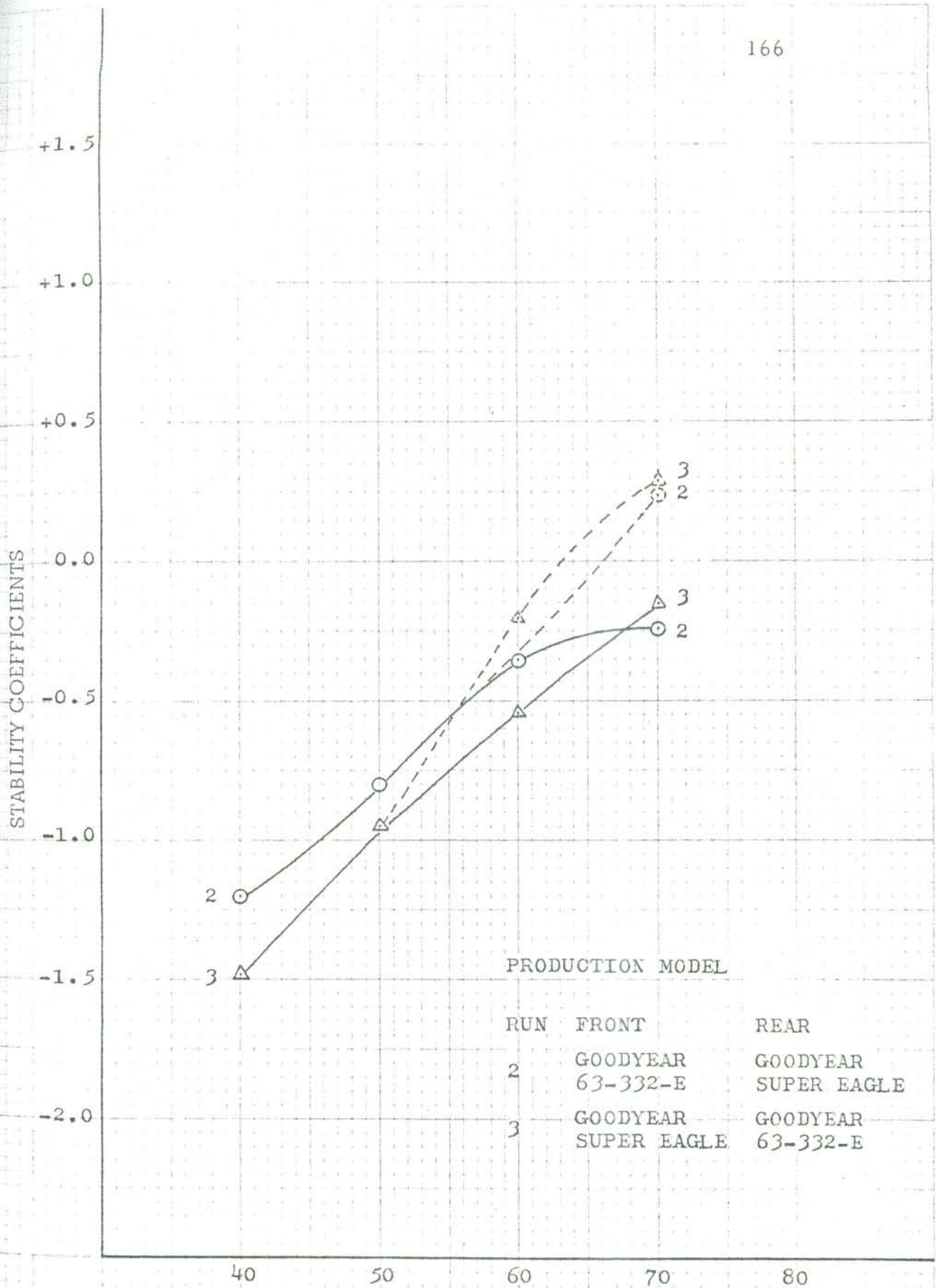

Fig. (10.26) SPEED IN MILES PER HOUR

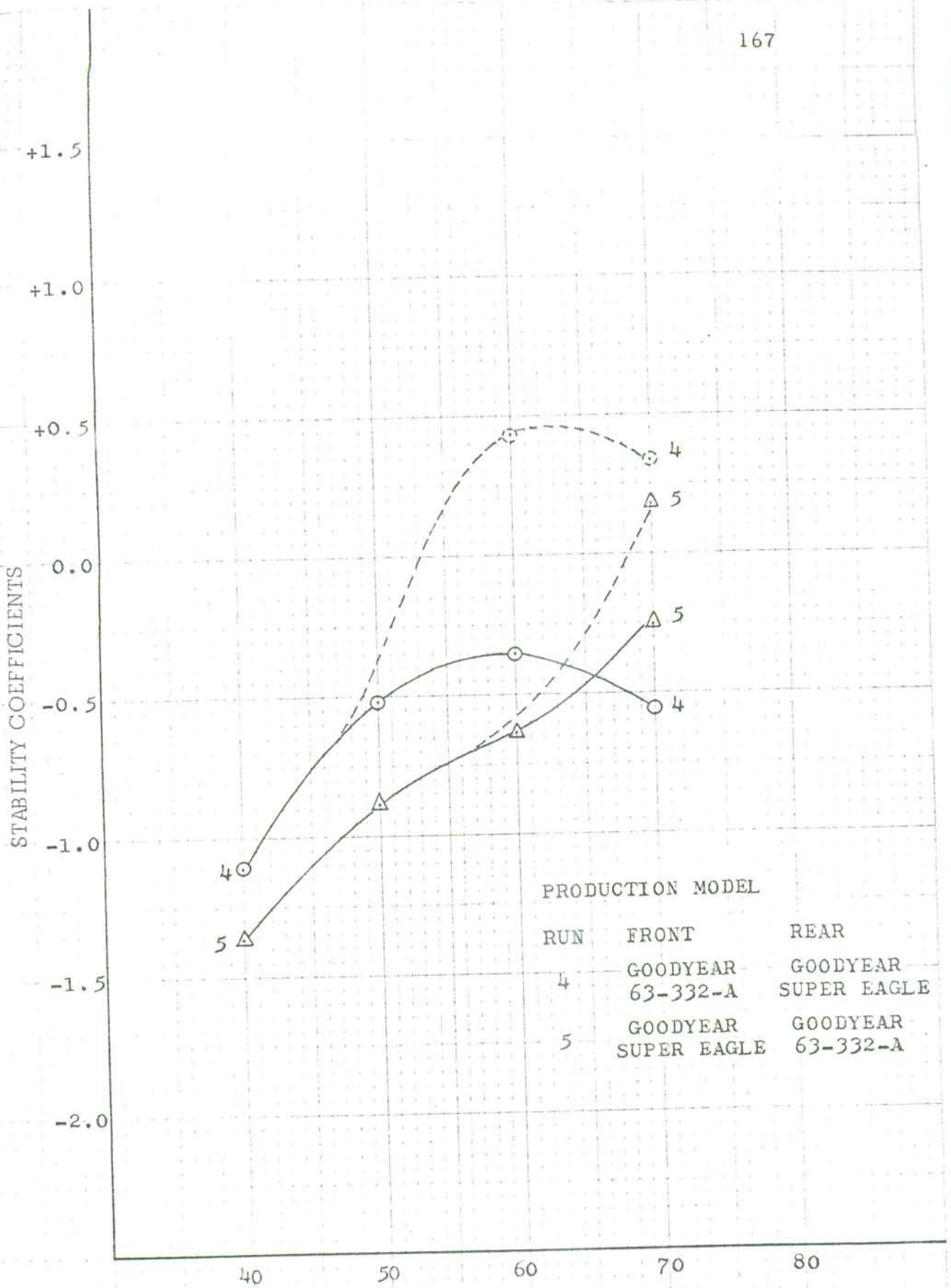
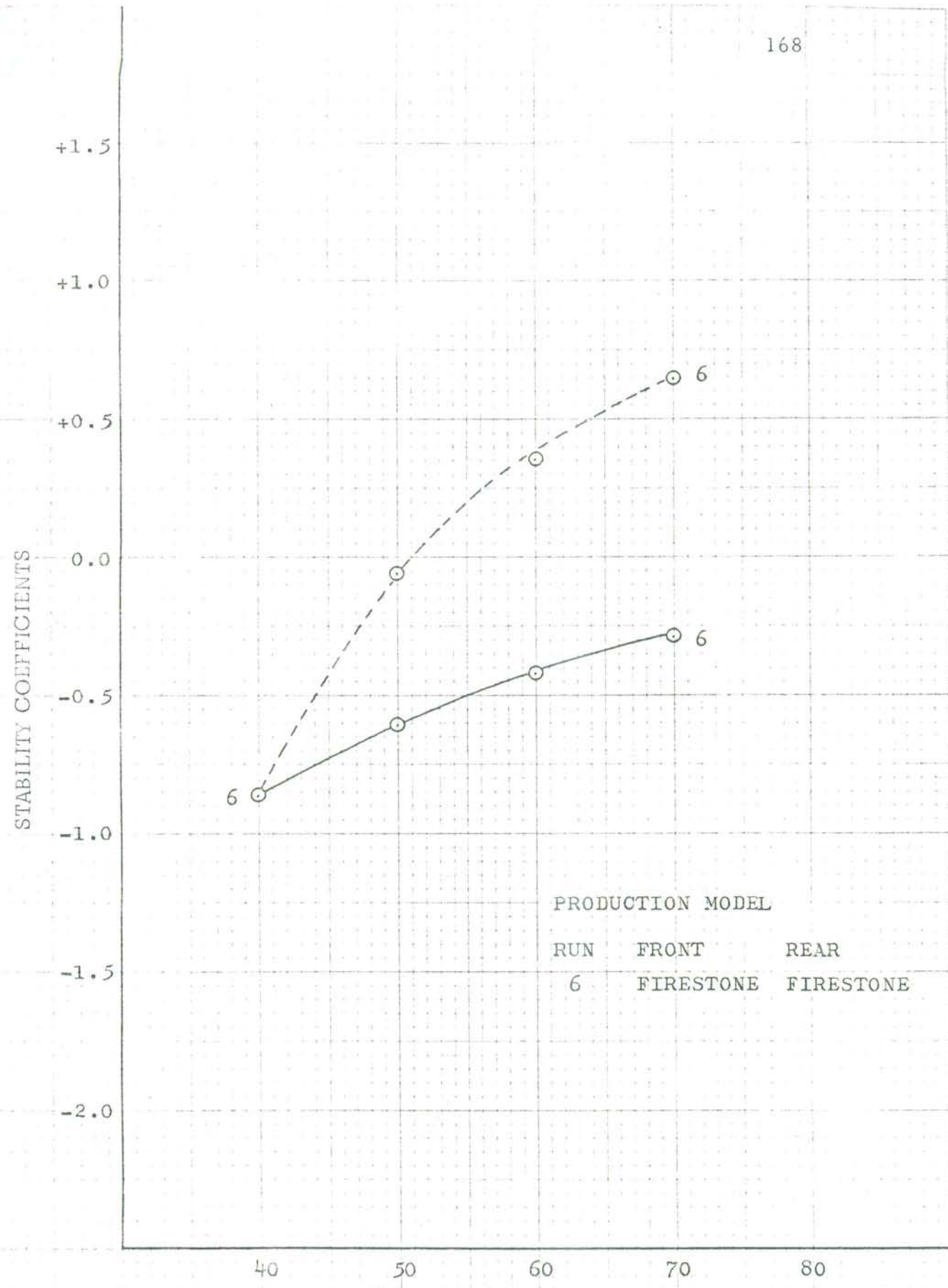

Fig. (10.27)

SPEED IN MILES PER HOUR



PRODUCTION MODEL
RUN FRONT REAR
6 FIRESTONE FIRESTONE

Fig. (10.28) SPEED IN MILES PER HOUR

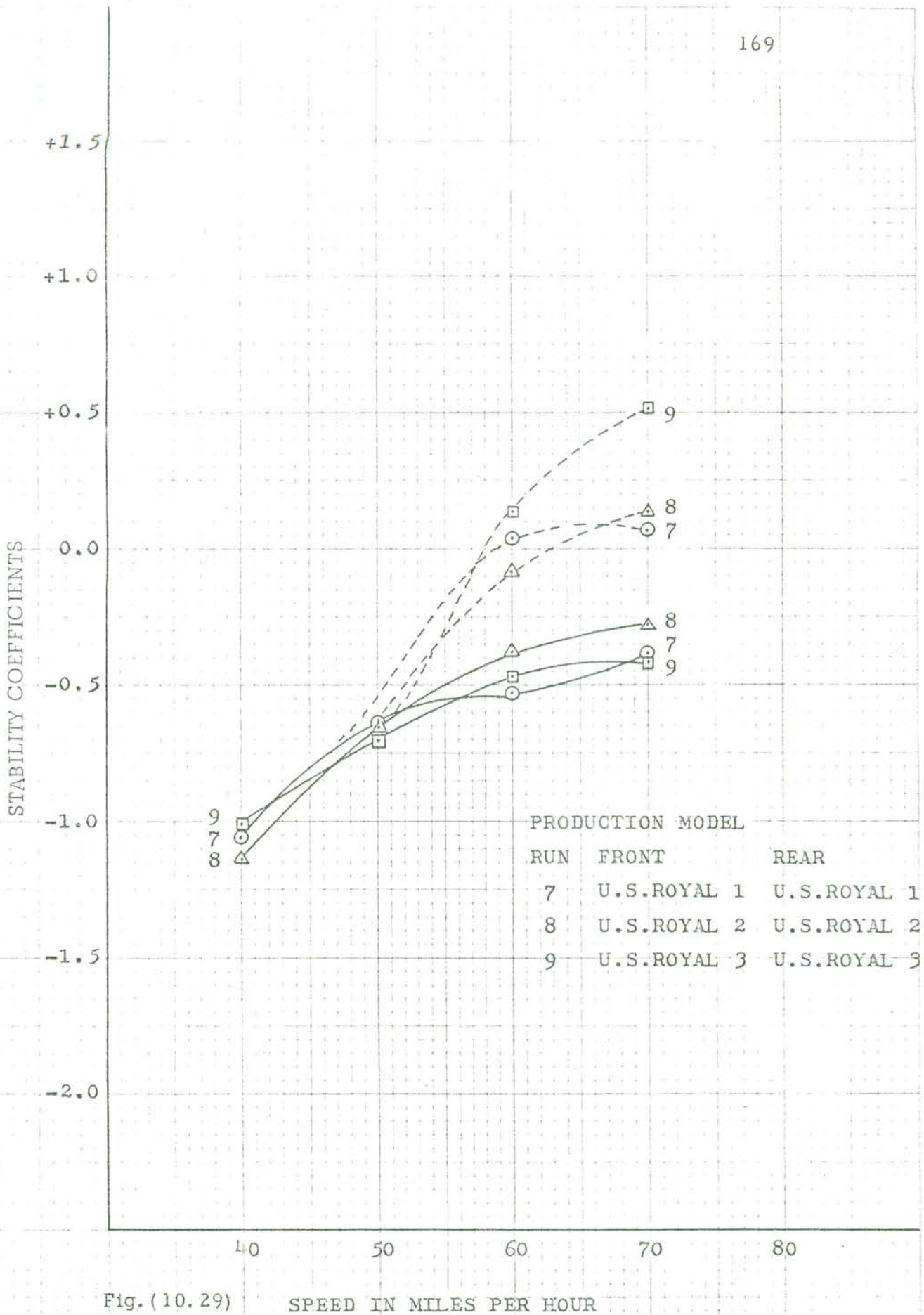

Fig. (10.29) SPEED IN MILES PER HOUR

STABILITY COEFFICIENTS

+1.5
+1.0
+0.5
0.0
-0.5
-1.0
-1.5
-2.0

40 50 60 70 80

PRODUCTION MODEL

RUN	FRONT	REAR
10	GOODYEAR SMOOTH	GOODYEAR SMOOTH
10a	SAME AS 10. THIS RUN MADE NEXT DAY	
11	WORN SE1	WORN SE3
12	WORN SE2	WORN SE3

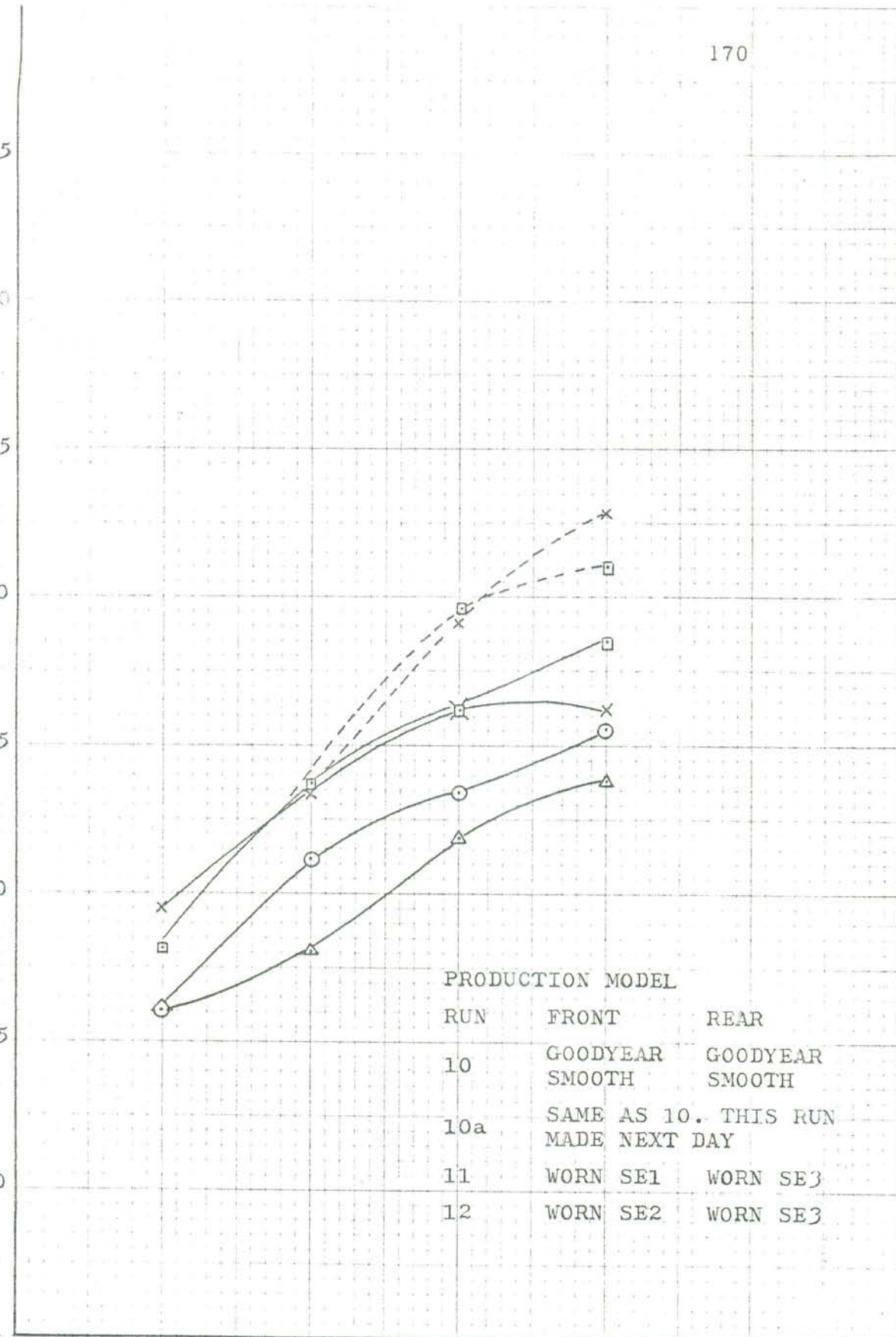

Fig. (10.30) SPEED IN MILES PER HOUR

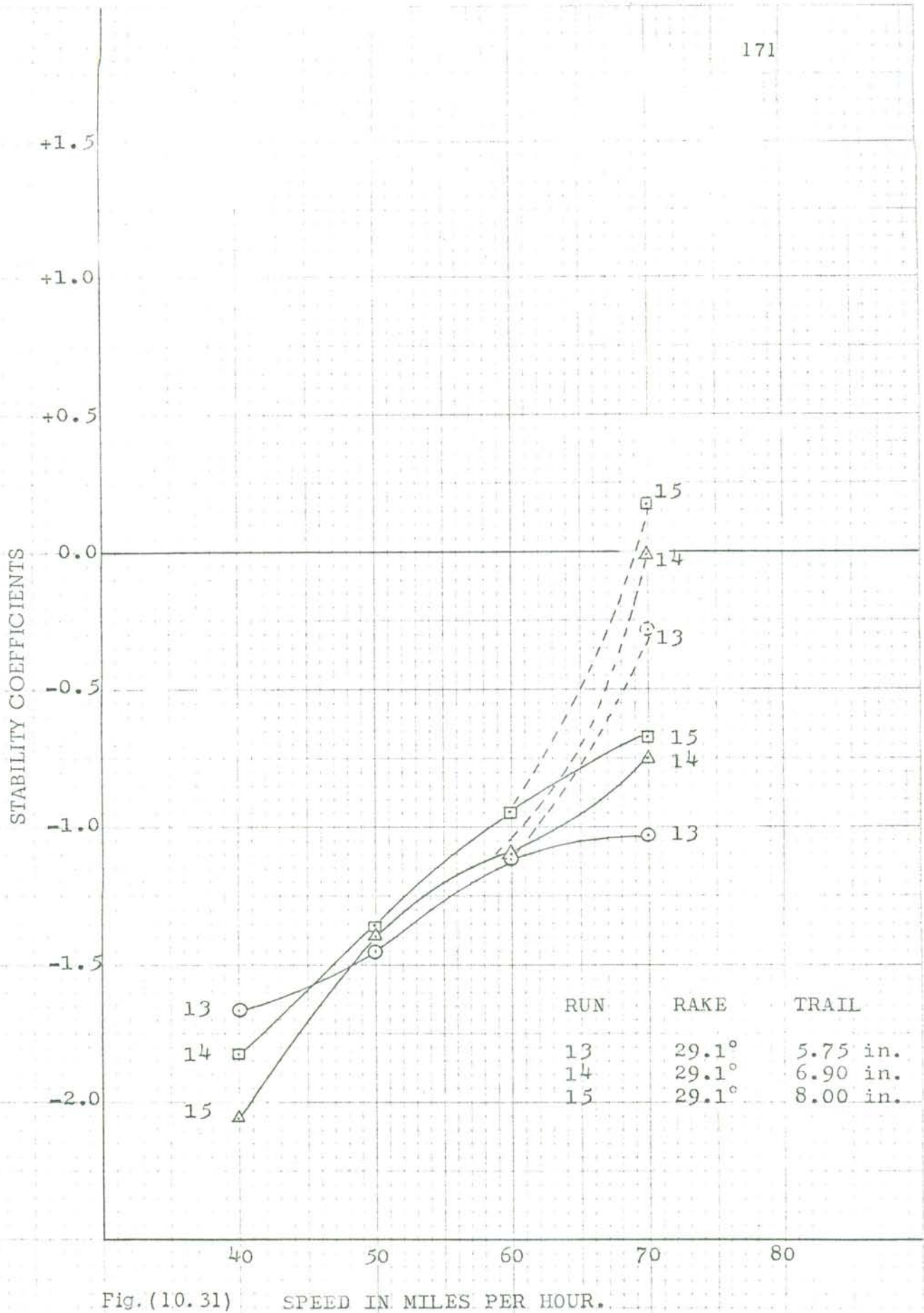

Fig. (10.31)

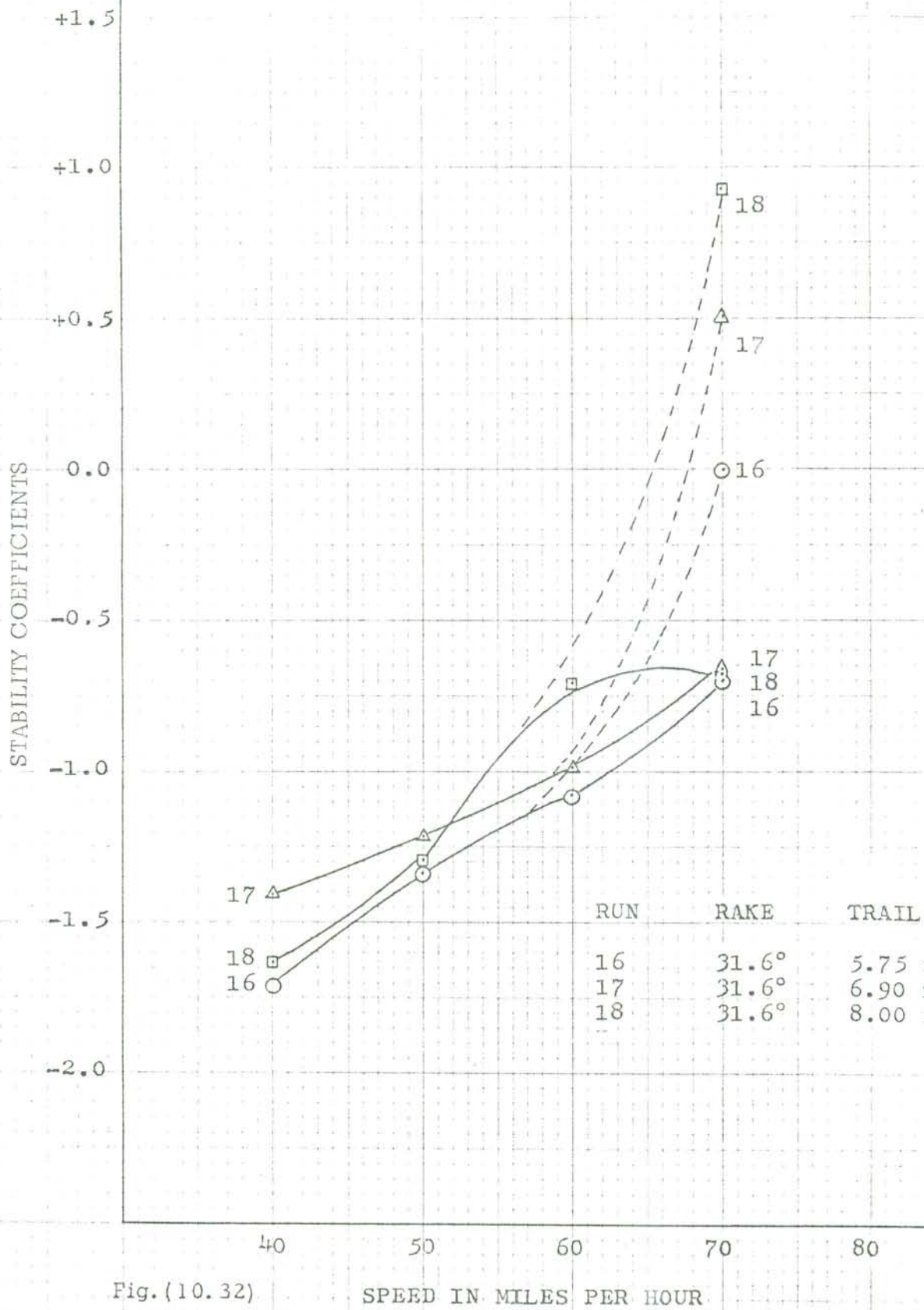

Fig. (10.32)

SPEED IN MILES PER HOUR

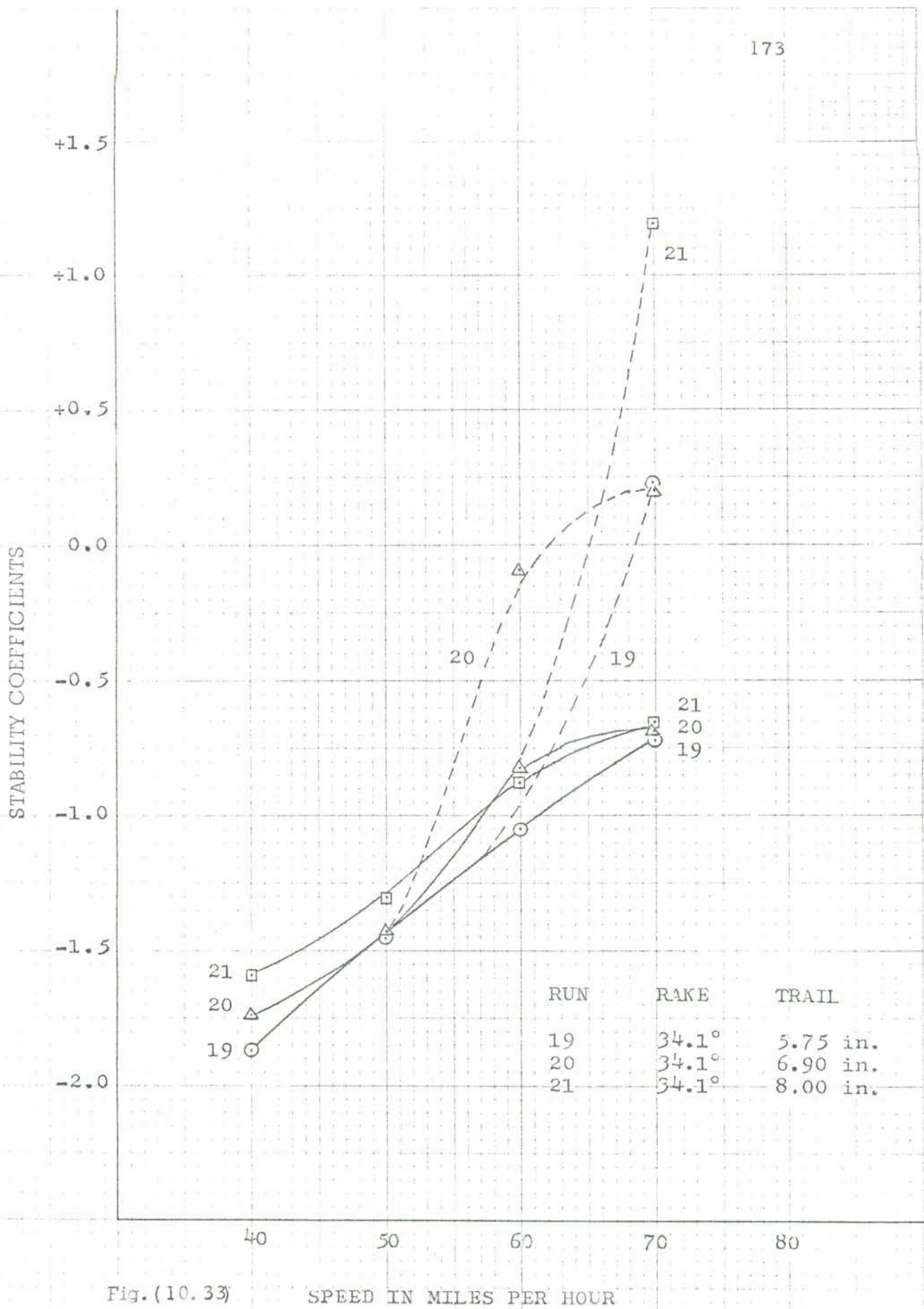

Fig. (10.33)

SPEED IN MILES PER HOUR

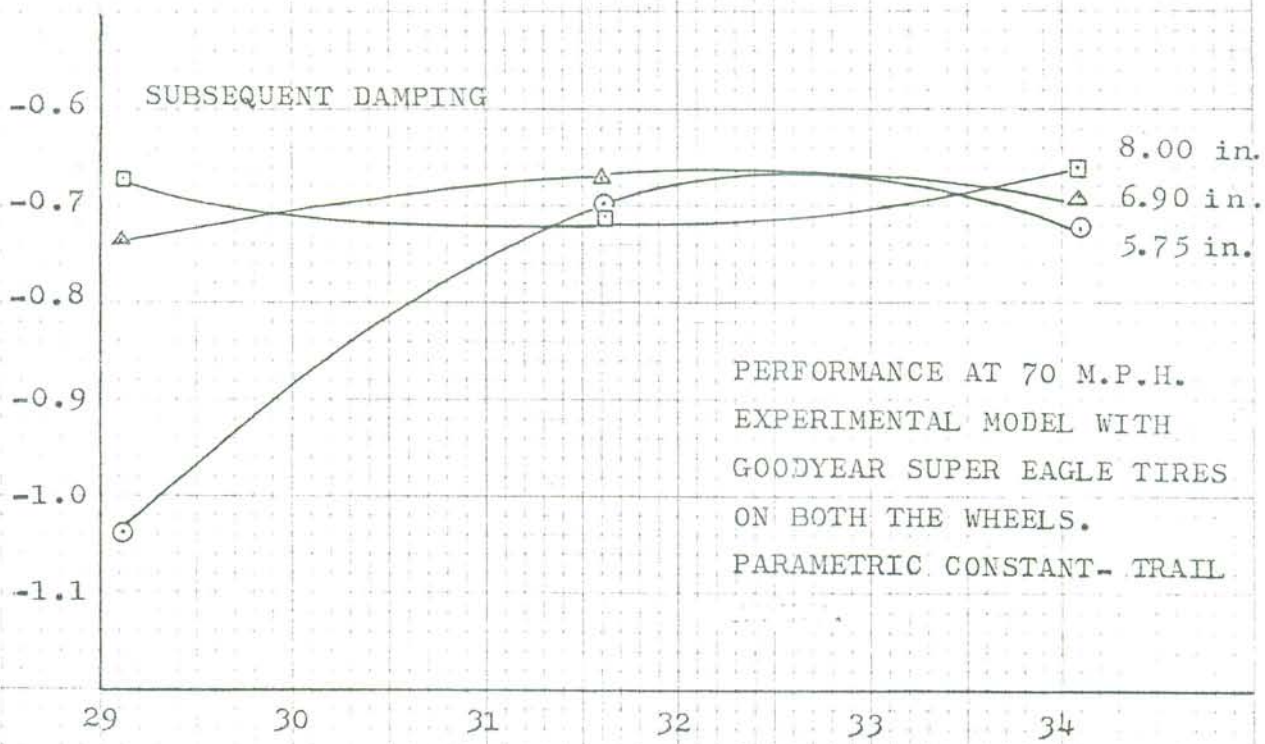
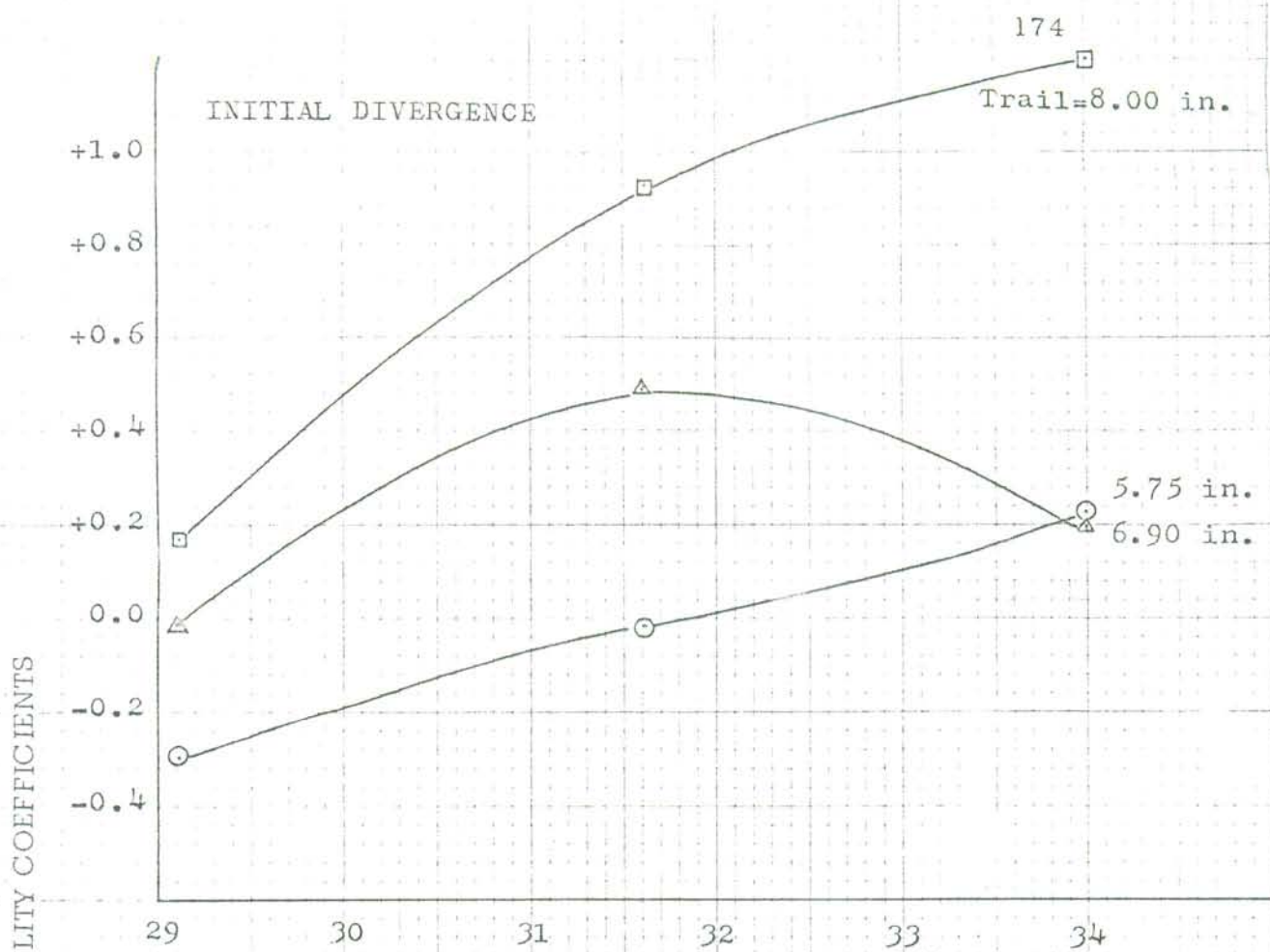

Fig. (10.34) RAKE ANGLE IN DEGREES

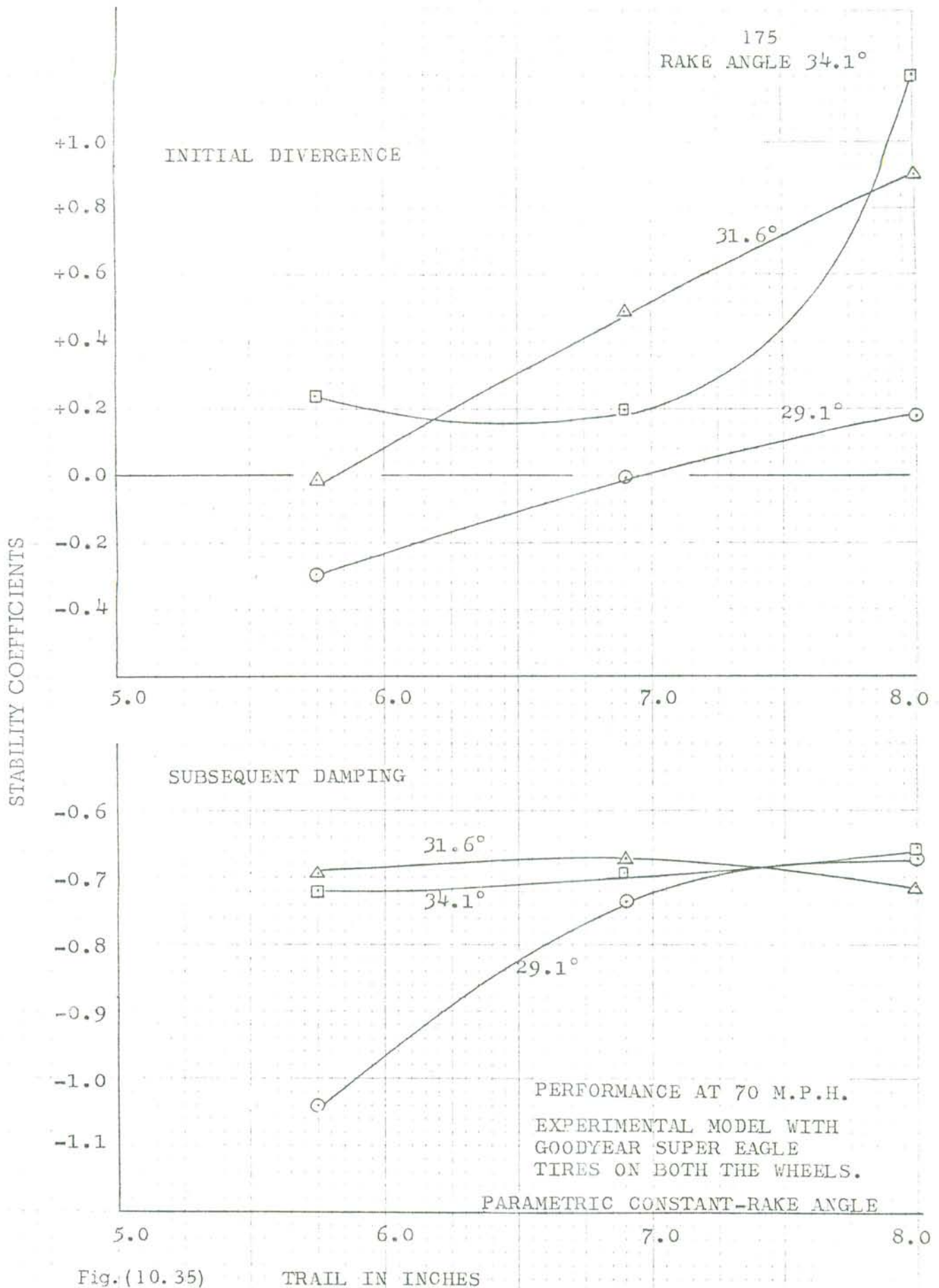

Fig. (10.35)

TRAIL IN INCHES

CHAPTER 11

DISCUSSION OF RESULTS AND CORRELATION

The analytical investigations were carried out for machine constants of a representative motorcycle, and not for the motorcycles used in the road tests. This entirely excludes any quantitative correlation and comparison of the analytical results with those of the road tests. At best, only a qualitative comparison of motorcycle performance, as indicated by the analytical solutions and as observed in the test runs, can be made.

The method of reduction of data implies that the real part of the complex root has been evaluated from the oscillograph records. This implication will be true even if the component motion corresponding to real roots were significant (which were really not in any run). The real root is of consequence in comparing instability in Region 3 and possibly in Region 5. In the theoretical solutions, Region 5 never appears, and Region 3 might have appeared, but only in one case (the steering damper study), at very low speed and high steering damping. There is no sharp boundary between Region 2 and Region 3, because there is no way to predict the maximum positive value of real root, which is beyond the control of normal riding skill unaided by extra driver effort. Therefore, the behavior of the motorcycle in Gaussian plane is significant in comparing the experimental results.

The most important agreement in the analytical and experimental results is the general decline in stability as the road speed goes up, with the same exception in each case. The exception is the motorcycle situation in which front wheel moment of inertia I_I^* is increased.

The most significant disagreement between the theory and the experiment is on the variation of the frequency of oscillation over a range of speed. It was found from the results of the road tests that the frequency of steering oscillation, for all the motorcycle situations, remained close to 2 cycles per second over the entire speed range. The theory indicates a change of reduced frequency f^* , from 1.5 at Froude number 8.226, to 1.76 at Froude number 32.90. This will be, for the representative motorcycle model of the theory, approximately equivalent to 3.6 cps. at 13.6 mph and 4.28 cps. at 54.4 mph. The representative motorcycle model of the theory is smaller than the Harley Davidson Machine. Therefore the equivalence of f^* will require higher value of "f" for the model of the analytical study. This tends to explain the higher frequency values obtained in the theory. As a matter of fact, the variation of frequency is more sizable in higher speed range of theoretical results.

The frequency contrast pointed out above is not very objectionable considering that the figures, illustrating the difference, have

a lower speed of only 13.6 mph, whereas the minimum test speed was 45 mph. Still, there is no indication to suggest that tests on lower test-speeds would have resulted in any decrease in frequency.

The theoretical results of Chapter 9 cannot possibly explain the initial divergence observed in some of the runs of the road tests, since the magnitude of θ in those situations are of the order of 2° to 3° and the validity of the linearized equations in this domain is questionable. However, on the basis of stability criteria discussed in Chapter 1, there is a very likely explanation. In those motorcycle situations, which show initial divergence, the characters of motion in the linear domain and in the nonlinear domain are not the same. In the nonlinear domain, the motion is unstable while in the linear domain it is stable. Immediately after the steering input of the driver, the machine is thrown into the nonlinear domain (since θ is large), and the oscillations begin to grow. Although the rider had his hands off the handle bar, he is surely introducing corrective input, by shift of his body weight (Fig. 11.1), to control the machine when the steering oscillations grow up to a magnitude where he cannot help reacting to it. Once the oscillations are cut down by the corrective input of the rider, to within the linear domain, the θ -trace indicates what is termed as subsequent damping. In those cases, where the initial behavior is not a divergence but a damping

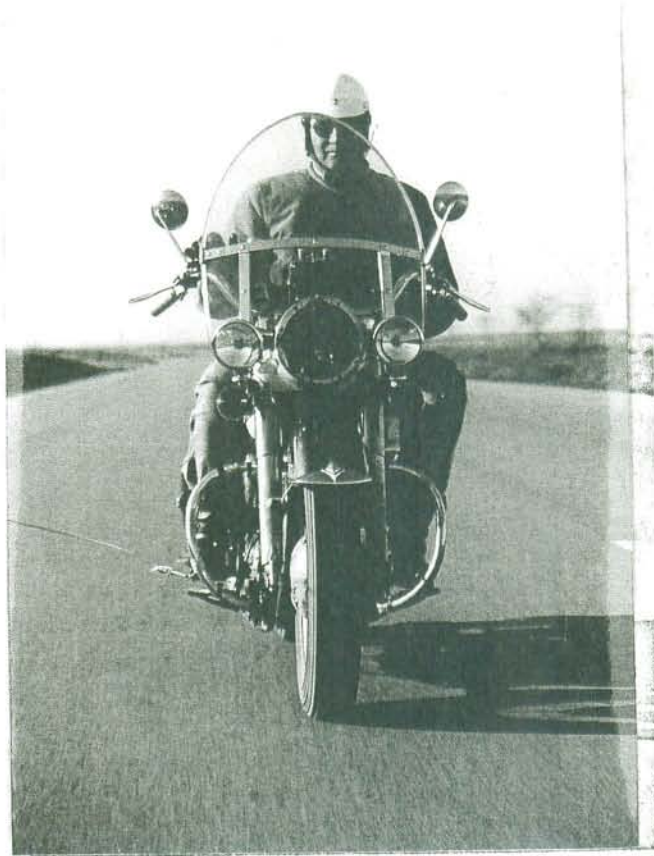

Fig. (11.1) Driver Input by Shift of His Weight During Actual Test Run

at a rate slower than that of subsequent damping, the character of motion, although stable, is significantly different from that in linear domain.

The study of the effects of variation in σ was made more for the purpose of examining the sensitivity of the theoretical solutions to change in σ , than to investigate and compare the stability itself. Since the effect is not very appreciable, and does not change the character of the solution over the entire range of Froude number, the constant value of .05 for σ , used to solve all the motorcycle situations, is not likely to introduce any sizable error in the solutions.

Investigation over a range of .65 to .85 of General Motors' tire values was also done with a dual purpose. Besides investigating the tire effect, it is important to establish that an apposite value .75 for z , represents realistically a certain tire pair which can be used to investigate the effect of other machine variables. The results show that although stability roots are affected by tires of different z -value, the character of motion is not. Hence $z = .75$, representing an arbitrary tire, is quite justified to be used to investigate other motorcycle parameters. Besides, the object of the study is only to compare the motorcycle performance, and not to compute quantitative stability coefficients to match with experimental data.

The theoretical results of Figs. (9.1), (9.2), (9.3), and (9.4) imply that tires of higher cornering power are good for stability. This improvement, suggested by theory, conforms to the improvements which were found in the road tests by the use of smooth tires. However, the theoretical improvements do not appear to be quite so substantial as that brought in by the smooth tires.

There are no inverse trends in results of Fig. (9.2), (9.3), and (9.4), and none with the change in Froude number, to suggest theoretically that different tires on the two wheels will conform to the experimental observation described in Chapter 10 (conclusion 13). The theoretical investigations have assumed symmetrical tires. An unsymmetry in either of the two tires, in actual practice, will be a source of disturbance and is likely to modify the motorcycle performance.

The effect of change in rake angle found from theory, in order to be correlated with the observed experimental results, needs discussion based on the hypothesis of the control of component motion corresponding to the real root. As long as the component motion is under the control of the riding skill, the effect of increasing rake angle improves stability. But for large positive value of real root, the motorcycle tends to be unstable. Since in practice, a driver will oppose oscillations about an off-zero mean, his large input may

result in forced oscillations in the unstable situation caused by a large positive value of real root. In the road tests, the change in motorcycle performance for the three different rake angles was small. In the theory too, the change in stability coefficient is less significant at higher Froude number than that at lower Froude number.

The slight change in the stability with change in rake angle, as observed in the road tests, contrary in trend to the theory, may be due to lack of effective control of riding skill on real root at larger rake angles. This supports the view that an optimum value of rake angle exists.

The effect of increase in trail in the Gaussian plane, like the effect of increase of rake angle, results in an improvement in the stability, which is also contrary to a small improvement trend observed on road with decrease in trail. This, however, lends itself to a similar explanation as is given for the rake angle effect. Only, the trend of real root grid in the trail study emphasizes the explanation more strongly. Making the trail negative has very adverse effect both in the Gaussian plane and on the real root grid. Negative trails were not tested, and no data are available to verify the theory for negative value of trails.

The gyroscopic effect of front wheel yields similar results both in theory and in test runs. Theoretical results however, show that

indefinitely increasing I_I^* may have an adverse effect at lower speeds. Experimental data are not available to check this conclusion. The result of change in m_I^* and of the effect of increasing I_I^* at lower speeds lend support to each other.

Study of change of gyroscopic effect of rear wheel was not experimentally made, therefore there are no data to verify the theoretical indication that this effect is only slight.

Both theory and experimental data suggest that reducing m_I^* results in an improvement of stability. According to the theory, this improvement is more pronounced at the lower Froude number than that at higher ones. Enough data are not available to check this fact.

In one of the test runs, head lamp, mirrors, windshield and signal lights were removed. This not only reduced m_I^* slightly, but also reduced the value of I_{33I}^* . A slight improvement in stability supports the theoretical trend of similar improvement for lower values of I_{33I}^* .

The experimental model had its center of gravity more forwarded in front of the steering axis as compared to its location on the production model. The experimental model had better stability than the production machine. But there are not enough data to verify the theoretical suggestion that there is an optimum value for a_I^* .

No road test data are available to verify the analytical results that h_I^* has little effect on stability and that decreasing h_{II}^* improves stability at all Froude numbers.

The fact that loading the rear fender in some of the test runs impaired, and forwarding the weight of the driver improved the stability, conforms to the theoretical indication of small improvement on increasing a_{II}^* .

The experimental runs included only one additional steering damper setting — the damper turned all the way down. The test results agree with the theoretical ones. Experimental data are not available to verify the theoretical indication of the performance of motorcycle at very high steering damping.

Recommendations

The recommendations to improve the performance of a two-wheeled vehicle, on the basis of the theoretical investigations, can be divided into two general groups. The first group includes those variables which do not have an optimum value. They can be changed as much as the design and the manufacturing considerations will permit. The second group consists of those machine variables which have optimum values.

The recommendations of the first group are

1. I_{33I}^* should be small.

2. m_I^* should be small.
3. h_{II}^* should be small.
4. a_{II}^* should be large.
5. Effect of h_I^* on stability behavior is slight, but its smaller value is more conducive to stability.
6. κ_j^* ($j = 1, 6, 1$) should be large, i. e., tires of higher cornering power are better for stability.

The recommendations of the second group are as follows.

1. Rake Angle = 31°
2. Trail (nondimensional) = 7.39×10^{-2}
3. $\Gamma_I^* = 1.73 \times 10^{-2}$
4. $a_I^* = .1480$ to $.1570$

Many of the factors which affect stability also affect the handling characteristics. Therefore, some judgment is necessary to effectively use the recommendations of this section, especially of the second group.

On Gaussian plane, the effect of increase of Γ_I^* is adverse at lower speeds, but profoundly stabilizing at higher speeds. Very high value of Γ_I^* is likely to result in a very high positive value of real root in the real root grid, and a motorcycle may fall in Region 3 or Region 5. Theoretically, there is no way to assign a limit to the maximum positive value of real root which is under effective control

of normal riding skill, and experimentally, it is not even possible to determine the value of the real roots. However, a mathematically plausible value on real root grid, for situations where optimum conditions appear, is zero.

The recommendations in this section are made on the basis of an arbitrary positive value of .075 on the real root grid and Froude number 16.5, presuming that the riding skill will more than compensate the small positive values.

At lower speeds, steering damping has adverse effect, but at higher speeds the damping has an optimum value. At higher Froude number, a small damping is better than no damping at all. The bearing friction of the steering does introduce some damping. But without the practical data, it is not possible to determine if the friction damping will give optimum condition at larger Froude numbers. If additional damping is needed in higher speed range, the different requirement of steering damping over the entire range of speed can simultaneously be met only if a damper is provided which can be applied or released as desired.

It was observed on the road tests that small positive values of real part on Gaussian plane were under the control of the driver without any extra effort or fatigue. Hence it seems reasonable that a machine, having good handling characteristics at low speeds, but

having very small positive values on Gaussian plane at higher speeds, should be considered a good motorcycle.

In view of the above fact, the following additional guiding values are recommended.

Limits	Motorcycle
Real part of complex root < 0	Desirable
$0 \leq$ Real part $< + 0.4$	Acceptable
$+ 0.4 <$ Real part < 0.75	Needs continuous effort of driver
Real part $> .75$	May be dangerous

The above values are suggested entirely on the basis of experimental observations, and are to be taken only as a measure of acceptability of a design.

CHAPTER 12

SCOPE OF FURTHER WORK

A very elaborate testing program is needed, if the theory presented here is to be effectively and completely checked. It is suggested that a motorcycle, such as the experimental model of the Harley Davidson Motor Co., be completely measured for its machine constants. This measurement will be of little value unless reliable tire data for the tires to be used in experimental investigations are available. Although measurement of tire forces and moments will be a project in itself, yet without its undertaking a more rigorous verification of the theory cannot be done.

A knowledge of slip angle is essential, if the use of arbitrarily assumed value of σ is to be avoided. There seems to be no way to accurately determine the value of σ by experiment. However, an experimental method, which may give a fairly correct value of σ , is outlined below.

Let a motorcycle run on a known curve at constant speed and radius. There should be suitable instrumentation to measure accurately, not only the steering angle θ , but also the angle of lean ϕ . Knowing the speed, the degree of curve, ϕ , and motorcycle geometry, it is easy to compute very accurately the steering angle required to keep the machine on the curve under equilibrium. The difference

between the steering angle measured and the one computed multiplied by the cosine of rake angle is slip.

The theory presented in nondimensional form is particularly adaptable for aside information. Various parameters have physical associations. The computation of these parameters require only two statements, PUNCH and FORMAT, in the computer program. A simultaneous plot of some of the more significant parameters will present a more comprehensive picture of the motion. Effect of a group of variables on the stability can also be investigated.

The hypothesis used to interpret the roots of characteristic equation involved the unknown input of the rider. Still, for investigating stability, the riding skill and quantitative driver input are only of academic interest. The important practical problem is to perfect a motorcycle such that it tends to absorb small disturbances over a satisfactory range of speed without much effort of the driver.

APPENDIX A

Motorcycle Constants*

$a_I = -0.8 \text{ ft}$	$l_I = -0.3 \text{ ft}$
$a_{II} = 2 \text{ ft}$	$l_{II} = 2 \text{ ft}$
$b_I = 3 \text{ ft}$	$m_I = 4 \text{ Sl}$
$b_{II} = 2 \text{ ft}$	$m_{II} = 15 \text{ Sl}$
$C_I = 0.008 \text{ lb}_f \text{ sec}^2 / \text{ft}^2$	$I_{13I} = 0 \text{ Sl ft}^2$
$C_{II} = 0.002 \text{ lb}_f \text{ sec}^2 / \text{ft}^2$	$I_{13II} = 0 \text{ Sl ft}^2$
$C_f = 0 \text{ lb}_f \text{ ft sec}$	$r_I = 1 \text{ ft}$
$d_{II} = 2 \text{ ft}$	$r_{II} = 1 \text{ ft}$
$h_I = 1.5 \text{ ft}$	$\alpha = 30^\circ$
$h_{II} = 1.5 \text{ ft}$	$\sigma = .05$
$I_{11I} = 1 \text{ Sl ft}^2$	$z = .75$
$I_{11II} = 3 \text{ Sl ft}^2$	$\kappa_1 = 8580 \text{ lb}_f$
$I_{33I} = 0.5 \text{ Sl ft}^2$	$\kappa_2 = 152 \text{ lb}_f \text{-ft}$
$I_{33II} = 8 \text{ Sl ft}^2$	$\kappa_3 = 268 \text{ lb}_f \text{-ft}$
$I'_I = 1 \text{ Sl ft}^2$	$\kappa_4 = 942 \text{ lb}_f \text{-ft}$
$I'_{II} = 2 \text{ Sl ft}^2$	$\kappa_5 = 26.8 \text{ lb}_f \text{-ft}$
$R \text{ (computed)} = 5.413 \text{ ft.}$	$\kappa_6 = 642 \text{ lb}_f \text{-ft}$

* Machine constants other than tire parameters are taken from Ref. (4).

APPENDIX B

Computer Programs

The computer programs were written for an IBM-1620 computing machine.

The program computing the coefficients of the characteristic equation takes about six minutes reading time, and about two minutes to solve each motorcycle situation. This program is run on FOR-TO-GO.

The dumped deck of the "Root Solver" takes about three minutes reading time, and one and a half minute to solve each equation. This program is run on FORGO.

C MACHINE CONSTANTS

READ, A1, A2, B1, B2, C1, C2, D2, H1, H2, AL1, AL2, AR, AII1, AII2

READ, AKPA1, AKPA2, AKPA3, AKPA4, AKPA5, AKPA6

READ, AIX1, AIX2, AIZ1, AIZ2, PXZ1, PXZ2, AM1, AM2, G

Z = .75

SGMA = .05

PAEE = 3.14159

SALFA = 28.

5000 PUNCH 6000, SALFA

6000 FORMAT(21H ALFA IN DEGREES = F4.1)

ALFA = (SALFA/180.) * PAEE

D1 = (1./COSF(ALFA)) * (H2 + D2 + SIN F(ALFA) * (A1 - AL1)) - H1

R = (A1 - AL1) * COSF(ALFA) + A2 + AL2 + (H1 + D1) * SIN F(ALFA)

XKPA1 = AKPA1 / (AM2 * G * R)

XKPA2 = AKPA2 / (AM2 * G * R)

XKPA3 = AKPA3 / (AM2 * G * R)

XKPA4 = AKPA4 / (AM2 * G * R)

XKPA5 = AKPA5 / (AM2 * G * R)

XKPA6 = AKPA6 / (AM2 * G * R)

XA1 = A1 / R

XA2 = A2 / R

XB1 = B1 / R

XB2 = B2 / R

XC1 = C1 * R / AM2

XC2 = C2 * R / AM2

XD1 = D1 / R

XD2 = D2 / R

XH1 = H1 / R

XH2 = H2 / R

XL1 = AL1 / R

XL2 = AL2 / R

XR = AR / R

XII1 = AII1 / (AM2 * R * R)

XII2 = AII2 / (AM2 * R * R)

XIX1 = AIX1 / (AM2 * R * R)

XIX2 = AIX2 / (AM2 * R * R)

XIZ1 = AIZ1 / (AM2 * R * R)

XIZ2 = AIZ2 / (AM2 * R * R)

XPXZ1 = PXZ1 / (AM2 * R * R)

XPXZ2 = PXZ2 / (AM2 * R * R)

XM1 = AM1 / AM2

XM2 = 1.

S1 = Z * (COSF(2.*ALFA) * (XL1 - XA1) - SIN F(2.*ALFA) * (XD1 + XH1))

S2 = (1. - Z) * (SIN F(ALFA) * (XD2 + XH2) - COSF(ALFA) * (XL2 + XA2))

Q1 = S1 + S2

S3 = COSF(2.*ALFA) * (XL1 + XA1) * SIN F(ALFA) / COSF(ALFA)

S4 = -SIN F(ALFA) * SIN F(ALFA) * (2.*(XD1 + XH1))

Q2 = S3 + S4

Q3 = SIN F(ALFA) * (XL1 * COSF(2.*ALFA) / COSF(ALFA) - 2.*XD1 * SIN F(ALFA))

Q4 = XR * XR * (-XL1 * COSF(2.*ALFA) + XD1 * SIN F(2.*ALFA))

Q5 = XR * XR * (XD2 * SIN F(ALFA) + XL2 * COSF(ALFA))

S5 = (1./COSF(ALFA)) * (COSF(2.*ALFA) * (XL1 + XA1) - SIN F(ALFA) * (XD2 + XH2))

Q6 = S5 + XA2 + XL2 - 2.*SIN F(ALFA) * (XD1 + XH1)

Q7 = XL1 * COSF(2.*ALFA) / COSF(ALFA) - 2.*XD1 * SIN F(ALFA)

```

Q8=-XD2*SINF(ALFA)/COSF(ALFA)+XL2
S6=XR*(XD1*SINF(2.*ALFA)*(XA1+XH1*SINF(ALFA)))
Q9=S6-XR*XL1*COSF(2.*ALFA)*(XA1+XH1*SINF(ALFA))
Q10=XR*XA2*(XL2*COSF(ALFA)+XD2*SINF(ALFA))
Q11=XR*(XL1*COSF(2.*ALFA)-XD1*SINF(2.*ALFA))
Q12=XA1*(XL1*COSF(2.*ALFA)/COSF(ALFA)-2.*XD1*SINF(ALFA))
S7=XL1*COSF(2.*ALFA)*(XA1*SINF(ALFA)/COSF(ALFA)-XH1)
Q13=S7-2.*XD1*SINF(ALFA)*(XA1*SINF(ALFA)-XH1*COSF(ALFA))
Q14=XH2*(XD2*SINF(ALFA)/COSF(ALFA)-XL2)
Q21=((SINF(ALFA)/COSF(ALFA))*(XH2+XD2)+XA2+XL2)/(XA1-XL1)
S21=COSF(ALFA)*(XH2+Q21*XH1+XD2)-XA2-XD1
Q22=S21-SINF(ALFA)*(XL1*(Q21+1./COSF(ALFA))+XL2)
Q23=-SINF(ALFA)*(XH2+XD2)-COSF(ALFA)*(XA2+XL1*Q21+XL2)
S22=COSF(ALFA)*(XH2+Q21*(XH1+XD1)+XD2)-XA2-XD2*Q21
Q24=S22-XD2/COSF(ALFA)-XL2*SINF(ALFA)
Q25=Q21+1./COSF(ALFA)
S23=Z*COSF(ALFA)*(-Q22+Q25*(XH1-XA1*SINF(ALFA)))
Q26=S23+(1.-Z)*COSF(ALFA)*(Q24-Q25*XH2)
Q27=-Z*Q25*SINF(ALFA)*COSF(ALFA)*(1.+COSF(ALFA))
S24=Q25*COSF(ALFA)*(Z*(COSF(ALFA)+SINF(ALFA)*SINF(ALFA)))
Q28=S24-Q25*(1.-Z)*COSF(ALFA)
Q29=SINF(ALFA)*(-Q22+Q25*(XH1+XA1*SINF(ALFA)))
Q30=Q25*SINF(ALFA)*SINF(ALFA)*(1.-COSF(ALFA))
Q31=Q25*SINF(ALFA)*(COSF(ALFA)+SINF(ALFA)*SINF(ALFA))
Q32=SINF(ALFA)*(Q21*XH1*COSF(ALFA)-Q22)-Q23*COSF(ALFA)
Q33=XA2
Q34=-Q22*(XR*XR)*COSF(ALFA)
Q35=-Q24*(XR*XR)*COSF(ALFA)
Q36=-Q22-Q24+Q25*(XH1+XA1*SINF(ALFA)+XH2)
Q37=Q25*SINF(ALFA)
Q38=Q25*(COSF(ALFA)+SINF(ALFA)*SINF(ALFA)+1.)
Q39=Q22*XR*COSF(ALFA)*(XA1+XH1*SINF(ALFA))
Q40=-Q24*XA2*XR*COSF(ALFA)
Q41=-Q22*XR*COSF(ALFA)
Q42=-Q22*XA1
Q43=-Q22*XA1*SINF(ALFA)+Q22*XH1*COSF(ALFA)
Q44=Q24*XH2
XXM1=XM1*Q3
XXM2=XM1*Q4
XXM3=XM2*Q5
XXM4=XM1*Q7
XXM5=XM2*Q8
XXM6=XM1*Q9
XXM7=XM2*Q10
XXM8=XM1*Q11
XXM9=XM1*Q12
XXM10=XM1*Q13
XXM11=XM2*Q14
XXM21=XM1*Q32
XXM22=XM2*Q33
XXM23=XM1*Q34
XXM24=XM2*Q35
XXM25=-XM1*Q22
XXM26=-XM2*Q24
XXM27=XM1*Q39

```



```

XXM28=XM2*Q40
XXM29=XM1*Q41
XXM30=XM1*Q42
XXM31=XM1*Q43
XXM32=XM2*Q44
S31=XR*(-XIX1*SINF(2.*ALFA)*SINF(ALFA)-XPXZ1*SINF(3.*ALFA))
XHX1=S31-XPXZ2*SINF(ALFA)-COSF(ALFA)*(XIZ1*COSF(2.*ALFA)+XIZ2)
XHX2=XIZ1*COSF(2.*ALFA)/COSF(ALFA)
S32=-XIX1*SINF(2.*ALFA)+XIZ1*COSF(2.*ALFA)*SINF(ALFA)/COSF(ALFA)
S33=XPXZ1*(3.*SINF(ALFA)*SINF(ALFA)-COSF(ALFA)*COSF(ALFA))
XHX3=S32+S33-XIX2*SINF(ALFA)/COSF(ALFA)-XPXZ2
S34=Q25*XR*SINF(ALFA)*COSF(ALFA)*(XIX1+XIZ1*COSF(ALFA))
S35=Q25*XR*COSF(ALFA)*(XPXZ1*COSF(ALFA)+XPXZ2)
XHX21=S34+S35-Q25*XR*XPXZ1*SINF(ALFA)*SINF(ALFA)*COSF(ALFA)
XHX22=Q25*XIZ1*SINF(ALFA)
S36=Q25*(XIX1*COSF(ALFA)+XIX2-XPXZ1*SINF(ALFA)*(1.+COSF(ALFA)))
XHX23=S36+XIZ1*SINF(ALFA)*SINF(ALFA)
XXH1=XI11*XR*(-2.*SINF(ALFA))
XXH2=2.*XI11*SINF(ALFA)
XXH3=XI11+XII2
XXH21=Q25*XR*COSF(ALFA)*(XI11*(COSF(ALFA)+SINF(ALFA)**2.)+XII2)
XXH22=-Q25*XII1
XXH23=Q25*XII1*SINF(ALFA)*(-1.+COSF(ALFA))
XXC1=XC1*XR*XR*(XH1*Q21*COSF(ALFA)*COSF(ALFA)+Q23*SINF(ALFA))
XXC2=-XC2*XB2*(XR*XR)
XXC3=Q21*COSF(ALFA)*(XB1-XH1*COSF(ALFA))*(XR*XR)*XC1
W=20.
3 PUNCH 7, W
7 FORMAT(11H OMEGA = F5.1,18H RADIANS PER SEC.)
XW=W/SQRTF(G/R)
XXW=XW*XW
SY1=SGMA*(XKPA1*Q1+(2.*Z-1.)*(XKPA2*COSF(ALFA)-XKPA3*SINF(ALFA)))
SY2=XKPA4*Q2-SINF(ALFA)*XKPA5-(SINF(ALFA)**2./COSF(ALFA))*XKPA6
SY3=XXM1+(1.-SGMA)*XXW*(XXM2+XXM3+XXH1)
Y1=SY1+SY2+SY3
Y2=SQRTF(R/G)*((1.-SGMA)*(XXM6+XXM7+XHX1)+XXM8+XXH2)*XW
Y3=(R/G)*(XXM9+XHX2)
Y4=XKPA4*Q6-2.*XKPA5-2.*XKPA6*SINF(ALFA)/COSF(ALFA)+XXM4+XXM5
Y5=SQRTF(R/G)*(XXH3*XW)
Y6=(R/G)*(XXM10+XXM11+XHX3)
PUNCH 100, Y1, Y2, Y3, Y4, Y5, Y6
100 FORMAT(5XF11.5, 5F11.5)
SY4=SGMA*(XKPA1*Q26+XKPA2*Q27+XKPA3*Q28)+XKPA4*Q29+XKPA5*Q30
SY5=XKPA6*Q31+XXC1*XXW+XXC2*XXW+XXM21+XXM22
Y7=SY4+SY5+(1.-SGMA)*XXW*(XXM23+XXM24+XXH21)
Y8=SQRTF(R/G)*XW*((1.-SGMA)*(XXM27+XXM28+XHX21)+XXM29+XXH22)
Y9=(R/G)*(XXM30+XHX22)
Y10=XXM25+XXM26+XXC3*XXW+XKPA4*Q36+XKPA5*Q37+XKPA6*Q38
Y11=SQRTF(R/G)*XXH23*XW
Y12=(R/G)*(XXM31+XXM32+XHX23)
PUNCH 100, Y7, Y8, Y9, Y10, Y11, Y12
YY0=Y6*Y9-Y12*Y3
PUNCH 5, YY0
YY1=Y5*Y9+Y6*Y8-Y11*Y3-Y12*Y2
PUNCH 5, YY1

```



```
YY2=Y4*Y9+Y5*Y8+Y6*Y7-Y10*Y3-Y11*Y2-Y12*Y1
PUNCH 5, YY2
YY3=Y4*Y8+Y5*Y7-Y10*Y2-Y11*Y1
PUNCH 5, YY3
YY4=Y4*Y7-Y10*Y1
PUNCH 5, YY4
5  FORMAT(6XE14.7)
   W=W+20.
   IF(W-160.) 3,3,35
35  SALFA=SALFA+1.
   IF(SALFA-32.) 5000,5000,40
40  STOP
   END
```

```

C STABILITY OF TWO WHEELED VEHICLES
C SOLUTION OF THE CHARACTERISTIC EQUATION
DIMENSION A(7),B(7),C(7),D(10),RR(5),RI(5)
OMEGA=20.
PUNCH 9000, OMEGA
9000 FORMAT(9H OMEGA = F4.1)
5000 KOS=0
      KQN=0
      LA=1
      LR=2
      RI=0.
      R=0.
      KPN=0
      LRT=1
      KRM=0
      KNT=0
      KP=0
      KD=0
      ADP=0.
      ADQ=0.
20 FORMAT(2XE11.4,4H + OE11.4)
21 FORMAT(2XE11.4,4H - OE11.4,14H FREQUENCY = E11.4,5H C.P.S.)
      K=1
      READ 1,N
      I FORMAT(6X12)
      M=N+2
      N1=N+1
      DO 60 I=2,N
60 READ 65,A(I)
63 FORMAT(6XE14.7)
      DO 45 I=3,M
45 A(I)=A(I)/A(2)
      IF(N-2) 18,13,1004
C THIS IS A HOLLOW CHECK.
1004 DO 1210 I=2,N
      IF(ABS(A(I+1))-1.E-07) 1210,1211,1211
1210 LA=2
1210 CONTINUE
      Z1=N
      Z2=5.28318-5/Z1
      DO 1212 I=1,N
      Z3=I
      Z3=Z3*Z2
      RR(I)=COSF(Z3)*A(I)
      RI(I)=SINF(Z3)*A(I)
      IF(RI(I)) 1210,1214,1214
1214 PUNCH 20,RR(I),RI(I)
      GO TO 1212
1210 RII=-RI(I)
      FRQNC=ABSF(RII/(2.*5.14159))
      PUNCH 21,RR(I),RII,FRQNC
1212 CONTINUE
      GO TO 40
C THIS IS A BINOMIAL EXPANSION CHECK
1211 GO TO (1210,1451),LA

```

```

1218 Z1=N
      ZR=(ABSF(A(N)))*(1./Z1)
      CS=1.
      DO 1200 I=1,N
        Z3=1
        Z4=N-1+1
        CS =ZR*CS+Z4/Z3
        Z1=ABSF(A(I+Z3))
        IF(ABSF(CS/Z1-1.)-1.e-07) 1200,1200,1400
1200 CONTINUE
      IF(A(3)) 1220,+0,1221
1220 DO 1201 I=1,N
      RR(I)=ZR
      RI(I)=0.
1201 PUNCH 20,RR(I),RI(I)
      GO TO 40
1221 DO 1202 I=1,N
      RR(I)=-ZR
      RI(I)=0.
1202 PUNCH 20,RR(I),RI(I)
      GO TO 40
1400 GO TO (1000,1401),LR
C     THIS IS THE REAL ROOT ROUTINE
1401 LR=1
      LC=1
      LA=1
      EX=N
      EX=20./EX
      XC=-(10.**EX)
      A(2)=1.
      IF(-XC-1000.) 1300,1301,1301
1301 XC=+1000
1300 DX=-2.*XC
      DO 1401 I=2,N
        Z=N-I
1401  S(I)=Z*A(I)
        X=XC
        R=0.
      DO 1350 I=2,N
1350  R=X*R+A(I)
        R1=0.
        N1=N+1
      DO 1351 I=2,N1
1351  R1=X*R1+S(I)
        X=X+DX
1420 RO=R
        R10=R1
        R=0.
      DO 1352 I=2,N
1352  R=X*R+A(I)
        R1=0.
        N1=N+1
      DO 1353 I=2,N1
1353  R1=X*R1+S(I)
1300 IF(R) 1301,1400,1302

```



```

1301 IF(R0) 1301,1432,1433
1302 IF(R0) 1431,1432,1434
1303 IF(R1) 1421,1423,1333
1304 IF(R10) 1401,1423,1425
1305 IF(R1) 1401,1423,1425
1306 IF(R10) 1421,1423,1425
1431 IF(ABS(X)-1.E-45) 1471,1470,1470
1471 IF(DX/ABS(X)-1.E-09) 1440,1440,1433
1471 IF(DX-1.E-07) 1440,1440,1433
1435 X=X-DX
      DX=.1*DX
      R=R0
      R1=R10
      GO TO 1420
1440 X=-X/30. +X
      IF(X+X0) 1441,1304,1334
1441 R=0.
      DO 1334 I=2,3
1334 R=X*R+A(I)
      R1=0.
      N1=N+1
      DO 1333 I=2,N1
1333 R1=X*R1+A(I)
      DX=-X0-X
      X=-X0
      GO TO 1420
1433 X=-.7*DX+X
      DX=.1*DX
      R=R0
      R1=R10
      IF(ABS(X)-1.E-45) 1471,1470,1470
1471 IF(DX/ABS(X)-1.E-09) 1440,1440,1440
1471 IF(DX-1.E-07) 1433,1433,1420
1432 X=X-DX
1430 RR(K)=X
      R1(K)=0.
      PUNCH 20,RR(K),PI(K)
      K=K+1
      LC=2
      N=N-1
      N=N-1
      N=N-1
      DO 1431 I=2,N
1431 A(I)=X*A(I-1)+ (I)
      DO 1434 I=2,N
      L=N-1
1434 L(I)=2*A(I)
      IF(N=2) 1313,1313,1433
1433 R=0.
      DO 1336 I=2,3
1336 R=X*R+A(I)
      R1=0.
      N1=N+1
      DO 1337 I=2,N1
1337 R1=X*R1+L(I)

```

```

IF(ABS(F(R))-.1.E-25) 1400,1401,1401
1400 IF(ABS(F(R-1)-.1.E-25) 1430,1429,1429
1401 IF(ABS(F(R)-F(R/R0)-1.)-1.E-25) 1450,1429,1429
1429 R0=R
DX=-X0-X
X=-X0
IF(DX) 1004,1004,1420
1420 IF(X+X0) 1420,1433,1433
1426 X=X+DX
GO TO 1420
1433 GO TO (1434,1005),LA
1005 GO TO (1005,1004),LC
1434 DX=DX/2.
X=X-DX
R=R0
R1=R10
LA=2
GO TO 1420
C THIS IS THE END OF THE REAL ROOT ROUTINE
1000 IF(M=4) 14,15,4
4 I=1.
P=1.
10 B(1)=0.
B(2)=1.
C(1)=0.
C(2)=1.
DO 2 I=1,4
2 B(I)=-P*B(I-1)+Q*(I-2)+A(I)
DO 3 I=3,4
3 C(I)=-P*C(I-1)+Q*(I-2)+B(I)
C(I-1)=-P*C(I-2)+Q*(I-3)
DE=C(I-2)+C(I-3)-C(I-1)+C(I-2)
IF(ABS(DE)-1.E-25) 71,72,72
71 DE=.000001
DE=.000001
GO TO 10
72 DE=(10*(I-1)+10*(I-2)-10*(I-3)+C(I-2))/10
DE=(10*(I)+10*(I-2)-10*(I-1)+C(I-1))/10
T=IS WEPS100 TO GET 72 DE = 0.000001. 2000.
IF(ABS(P+DP)-1.E-25) 18,17,17
18 P=.001
IF(ABS(P+DP)-1.E-25) 17,17,17
17 DP=.000001
19 IF(ABS(Q)-1.E-25) 22,23,23
20 IF(ABS(R)-1.E-25) 23,24,24
24 IF(ABS(QC/2)-1.E-25) 6,6,6
6 IF(ABS(DP/P)-1.E-25) 7,7,7
25 IF(ABS(QD)-1.E-25) 26,26,7
26 IF(ABS(DP)-1.E-25) 7,7,7
3 GO TO (1000,2000,3000),LRT
1000 IF(ABS(DP)-ABS(R) 1001,1010,1010
1010 KP=KP+1
IF(KP=20) 1001,1011,40
1001 IF(ABS(QD)-ABS(R) 1001,1012,1012
1012 KW=KW+1

```

```

      IF(KN-20) 65,1011,40
1011 LRT=2
      KN=0
      KN=0
      IF(KRN=10) 2000,1100,40
1100 PUNCH 999
      999 FORMAT(44M ITERATION DIVERGENCE -- NO.3.8. NOT ACCEPTED.)
      GO TO 40
2000 KNT=KNT+1
      IF(OP)1030,1031,1031
1030 KPN=KPN+1
1031 IF(DQ) 1032,1033,1033
1032 KQN=KQN+1
1033 IF(KNT-20) 65,1041,40
1041 IF(KPN) 40,1041,1030
1030 IF(KPN-20) 1042,1043,40
1042 IF(KQN) 40,1041,1031
1031 IF(KQN-20) 1044,1045,40
1043 KPN=0
      KQN=0
      KNT=0
      DP=100.*DP
      DQ=100.*DQ
      LRT=1
      GO TO 65
1044 LRT=3
      KNT=0
      KPN=0
      KQN=0
3000 KOS=KOS+1
      O(KOS)=P
      O(KOS-20)=Q
      IF(KOS-20) 65,3001,40
3001 P=Q
      Q=0
      DO 3002 I=1,20
      P=P+O(I)
3002 Q=Q+O(I+20)
      P=P/20.
      Q=Q/20.
      KOS=0
      LRT=1
      ADP=ABS(P)
      ADQ=ABS(Q)
      GO TO 19
50 ADP=ABS(P)
      ADQ=ABS(Q)
      P=P+DP
      Q=Q+DQ
      GO TO 19
7 DES=P*P/4.-Q
      IF(DES) 10,11,0
11 RK(K)=-P/2.
      RK(K+1)=RK(K)
      GO TO 7

```



```

6 RR(K)=SQRTF(DES)-P/2.
  RR(K+1)=-P/2.-SQRTF(DES)
7 RI(K)=0.
  RI(K+1)=0.
  PUNCH 20, RR(K), RI(K)
  PUNCH 20, RR(K+1), RI(K+1)
  K=K+2
  IF(N-2) 40,17,32
10 RR(K)=-P/2.
  RI(K)=SQRTF(-DES)
  PUNCH 20, RR(K), RI(K)
  RANCY=ABSF(RI(K)/(2.*3.14159))
  PUNCH 21, RR(K), RI(K), RANCY
  K=K+1
  RR(K)=-P/2.
  RI(K)=-SQRTF(-DES)
  K=K+1
32 A(1)=0.
  A(2)=1.
  DO 30 I=3,N
30 B(I)=A(I)
  DO 31 I=3,N
31 A(I)=-Q*A(I-2)-P*A(I-1)+L(I)
  N=N-2
  M=M-2
  IF(M-4) 14,13,1004
14 IF(M-3) 17,13,40
13 P=A(3)
  Q=A(4)
  GO TO 7
18 RR(K)=-A(3)
  RI(K)=0.
  PUNCH 20, RR(K), RI(K)
17 CONTINUE
40 OMEGA=Q*ES+20.
4000 FORMAT(1H OMEGA = F3.1,10H RADIANS PER SEC.)
  IF(OMEGA-100.) 5001,5001,5000
5001 PUNCH 4000, OMEGA
  GO TO 5000
5000 OMEGA=OMEGA-100.
  PUNCH 4000, OMEGA
  GO TO 5000
  STOP
  END

```

BIBLIOGRAPHY

1. Bower, G. S., "Steering and Stability of Single Track Vehicles." *The Automobile Engineer* (1929).
2. Chetayen, N. G., The Stability of Motion. Pergamon Press, 1961.
3. Coddington, E. A., Levinson, N., Theory of Ordinary Differential Equations. McGraw Hill, 1955.
4. Collins, R. N., A Mathematical Analysis of the Stability of Two-Wheeled Vehicles. Ph.D. Thesis, University of Wisconsin. 1963.
5. Döhring E., Brunswick, "Stability of Single Track Vehicles." *Forschung Ing. Wes.* 21, no. 2, 50-62 (1955).
6. Fiala, E., "Seitenkräfte am rollenden Luftreifen": *Zeitschrift Des Vereines Deutscher Ingenieure*, Oktober 1954.
7. Fonda, A. G., Radt, H., "Summary of Cornell Aeronautical Laboratory Tire Test Data," Oct. 1958.
8. Ginn, J. L., Miller, R. F., "The B. F. Goodrich Tire Dynamics Machine," SAE 490B, 1962.
9. Goldstein, H., Classical Mechanics. Addison-Wesley Press.
10. Halfman, R. L., 'Dynamics' Vol. II — Systems, Variational Methods and Relativity. Addison-Wesley Publishing Co., 1962.
11. Heinrich, G., "Zu Föppl's These der rollenden Reibung." *Oster. Ing.-Arch.* vol. 4(1950), p. 363-370.
12. Irving, P. E., Motorcycle Engineering. Temple Press, London (1961).
13. Klein, F., Sommerfeld, A. The Theory of Gyroscope, Vol. IV, Technical Applications. Berlin and Leipzig, 1910.
14. Krasovskii, N. N. Stability of Motion. Stanford Univ. Press, 1963.
15. Langhar, H. W. Dimensional Analysis and Theory of Models. John Wiley, Inc.

16. Malkin, I. G., "Theory of Stability of Motion," AEC-tr-3352 United States Atomic Energy Commission.
17. Nordeen, D. L., Cortese, A. D., "Force and Moment Characteristics of Rolling Tires." S. A. E. International Summer Meeting June 1963, Montreal, Canada.
18. Nothstine, J. R., Beauvais, F. N. "Laboratory Determination of Tire Forces." S. A. E. International Summer Meeting June 1963, Montreal, Canada.
19. Pearsall, R. H., "The Stability of the Bicycle." Proc. Institute of Automobile Engineers, Vol. XVII (1922)
20. Pontryagin, L. S., Boltyanskii, V. G., Gamkrelidze, R. V., Mischenko, E. F. The Mathematical Theory of Optimal Process. John Wiley and Sons, Inc.
21. Rocard, Y. Dynamic Instability. Crosby Lockwood and Son, Ltd., London, 1957.
22. Taborek, J. J. Mechanics of Vehicles. Penton Publication.
23. Wallace, J. "The Super Sports Motorcycle." The Institute of Automobile Engineers Proceedings, XXIV, 161-231 (1929).
24. Wilson-Jones, R. A. "Steering and Stability of Single Track Vehicles," Proc. I. M. E. Auto. Div. 1951-52.
25. Younger, John E. Advanced Dynamics. Ronald Press Co., N. Y.

TITLE OF THESIS ADVANCED CONCEPTS OF THE STABILITY OF
TWO-WHEELED VEHICLES— APPLICATION OF MATHEMATICAL
ANALYSIS TO ACTUAL VEHICLES

Full Name DIGVIJAI SINGH

Place and Date of Birth LUCKNOW, (U.P.), INDIA, DECEMBER 11-1934

Elementary and Secondary Education HIGH SCHOOL (1949)

Colleges and Universities: Years attended and degrees ALLAHABAD UNIVERSITY, B.Sc. -
(1953); University of Roorkee, B.E. (Mech.)-(1956), B.E (Civil)-
(1957); both the universities in India
University of Wisconsin, M.S. (June 1962)

Membership in Learned or Honorary Societies _____

Publications _____

Major Department Mechanical Engineering

Minor(s) Civil Engineering

Date May 27, 1964

Signed A. H. Easton
Professor in charge of thesis

APPROVAL

The foregoing thesis is hereby approved as a creditable study of an engineering subject, carried out and presented in a manner sufficiently satisfactory to warrant its acceptance as a prerequisite to the degree for which it has been submitted. It is to be understood that by this approval, the undersigned does not necessarily endorse or approve any statement made, opinion expressed, or conclusions drawn therein, but approves the thesis only for the purpose for which it has been submitted.

Approved A. H. Easton
Date May 27, 1964